

愛知教育大学 外国人児童生徒支援リソースルーム

がっこうせいかつ ことばワーク

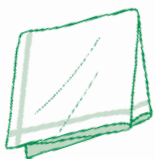
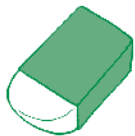
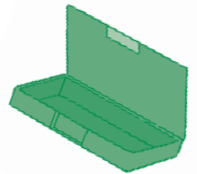
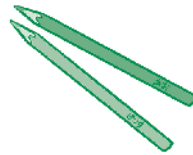

はじめに

日本の学校に通う、日本語指導が必要な子どもたちにとって大切なのは、新しい日本語のことばを覚えて終わるのではなく、覚えたことばを実際の場面で使えるようになることです。

「がっこうせいかつ ことばワーク」は、ことばと子どもの学校生活の場面をつなげることを意識して作成しました。

教室の机の上だけでワークのページを進めて、ことばの勉強を終わるのではなく、学校内のいろいろな場所、いろいろな先生や友達との関わりの中で、どんどんことばを使えるような、学びを活かす場面や環境づくりが大切です。そして子どもにとって、そばで見えてくれる先生の存在はとても心強く、先生の励ましが子どもの心を前向きにしてくれます。

このワークを進めながら、たくさんコミュニケーションをとり、ことばの広がりを子どもたちと一緒に楽しんでもらえることを願っています。

愛知教育大学 外国人児童生徒支援リソースルーム

目次

はじめに	1
つかいかた	3
①あいさつ	4
②がっこうのいちにち	10
③ふくそう・もちもの	16
④がっこう	26
⑤きょうしつ	36
⑥べんきょう	42
⑦からだ	56
⑧きもち・ようす	64
⑨かぞく	76
⑩つうがくろ	80
⑪カレンダー	90
⑫どうし	96
おまけのページ（すごろくコマ）	105
おまけのページ（すごろく）	107
間違い探しの答え	109

本書の使い方

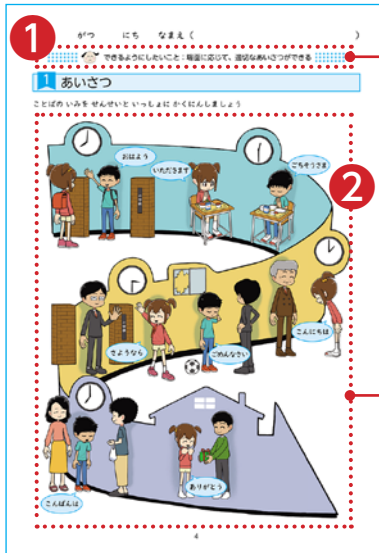

1 各項目の最初に、外国人児童生徒支援リソースルームのキャラクター「ムッシュ」が、ことばを身につけたその先に目を向け、「できるようにしたいこと」を確認しています。

2 まずは、場面のイラストを見ながら、ことばの意味を先生と一緒に確認しましょう。子どもや学校の状況に応じて、ことばを増やしたり、表現を変えたりしてください。

3 ことばと絵を線で結んだり、繰り返し書いたり、声に出して読んだりしながら、いろいろなパターンで練習を繰り返します。繰り返しの練習には別冊の絵カードもおすすめです。

① せんで むすびましょう

漢

せんすう しゃかい こくご りか

② かさみましょう

かけたら、ひえにだして・よみましょう

漢

こくご さんすう りか しゃかい

こくご さんすう りか しゃかい

おんがく どうとく ずこう たいいく

せいかつ がいこくご どうとく

せいかつ がいこくご どうとく

授業室や保健室で職員室に行って、先生にインクビューをします。

こうちようせんせい ほけんのせんせい たんにんのせんせい

がっこうのなかを たんけんしましょう

○こうちようしつに いってみましょう

・こうちようせんせいの なまえ ()

・すきな たべもの ()

○ほけんしつに いってみましょう

・ほけんのせんせいの なまえ ()

・すきな たべもの ()

○しよくいんしつに いってみましょう

・せんせいの なまえ ()

・すきな たべもの ()

4 多くの項目の最後に、練習問題のページがあります。子ども1人で練習するのではなく、先生とコミュニケーションを取りながら、楽しく取り組んでください。時には、教室を出て、ことばを使う世界を広げましょう。

できるようにしたいこと：場面に応じて、適切なあいさつができる

1 あいさつ

ことばの いみを せんせいと いっしょに かくにんしましょう

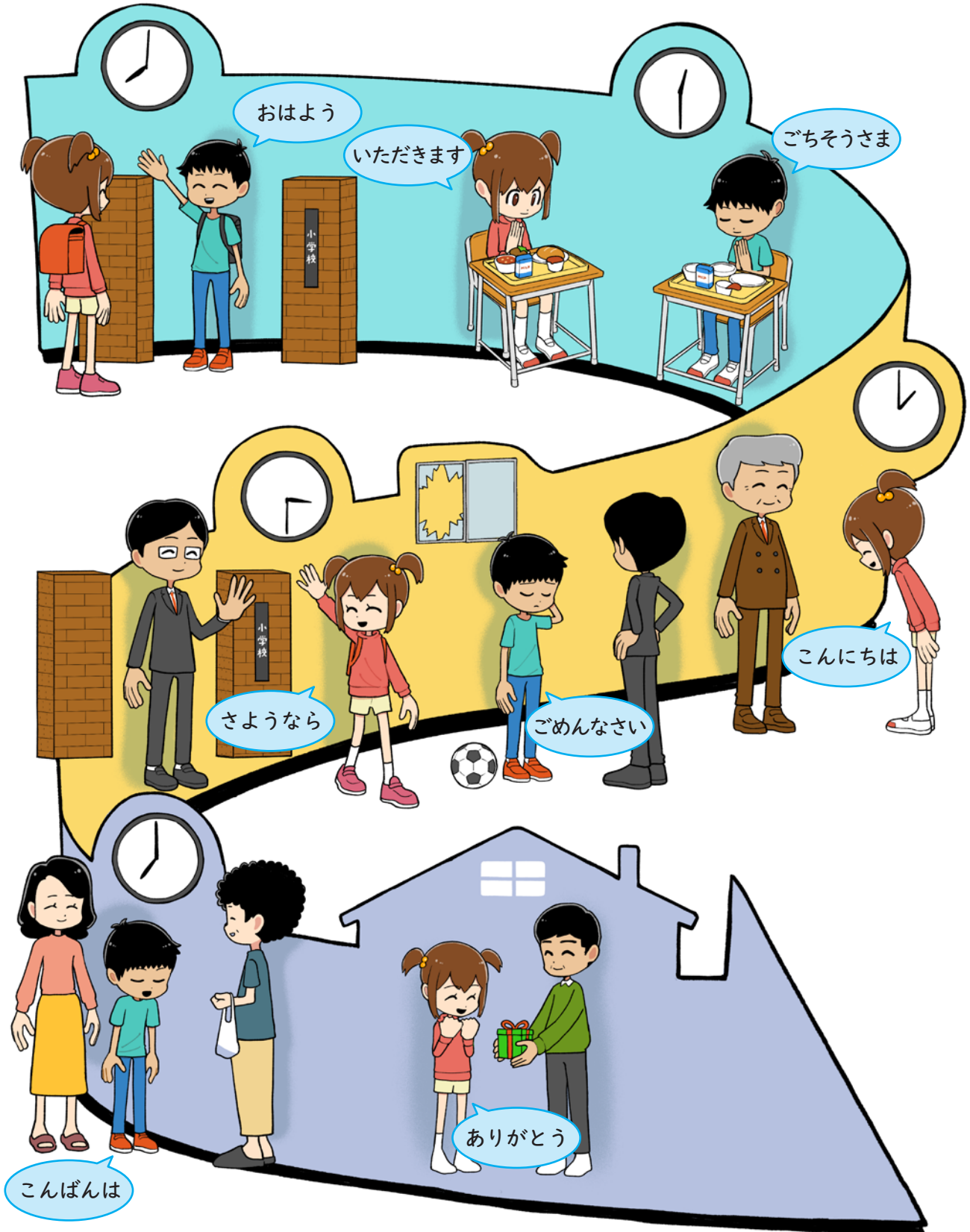

①. せんで むすびましょう

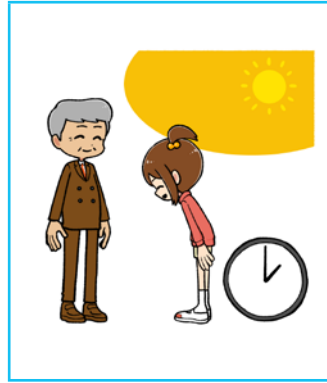
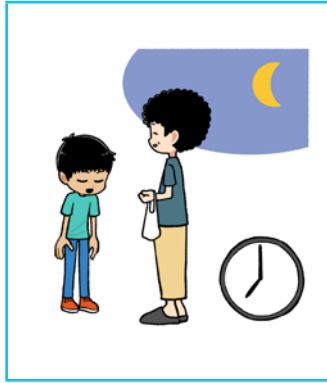

こんばんは

こんにちは

さようなら

おはよう



いただきます

ごちそうさま

ありがとう

ごめんなさい



かきましょう



かけたら、こえにだして よみましょう

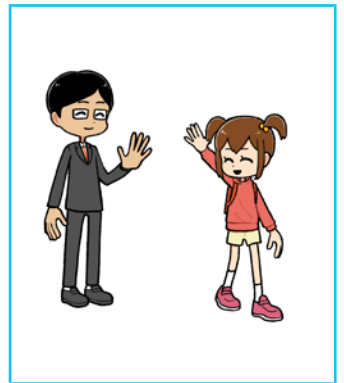
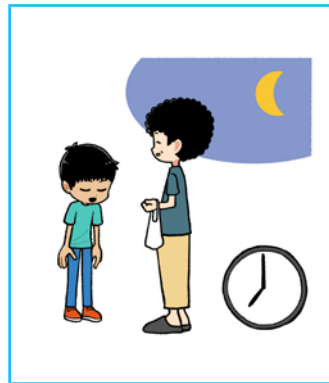
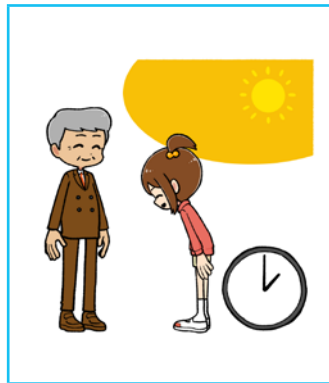
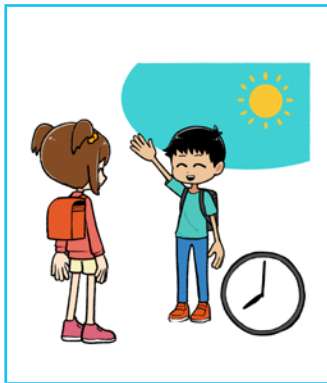

おはよう

こんにちは

こんばんは

さようなら

おはよう

こんにちは

こんばんは

さようなら

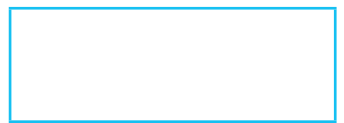
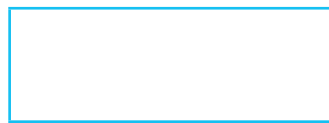
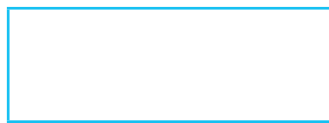
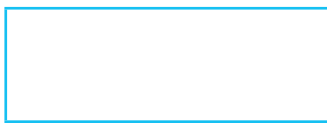

ありがとう

ごめんなさい

いただきます

ごちそうさま

ありがとう

ごめんなさい

いただきます

ごちそうさま

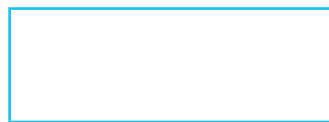
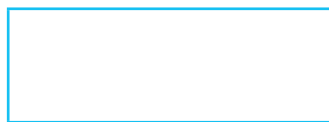
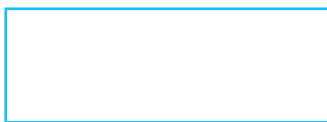



ことばを えらんで かきましょう

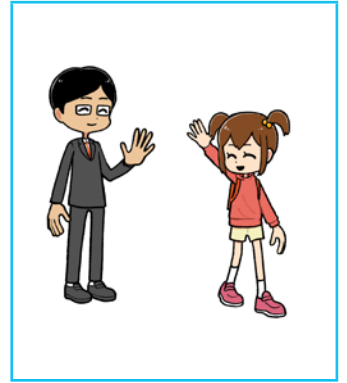
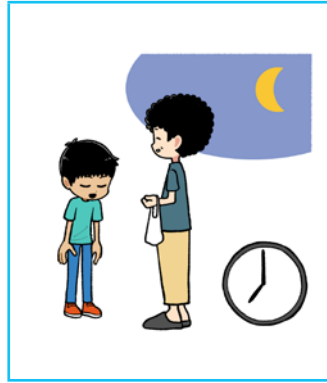
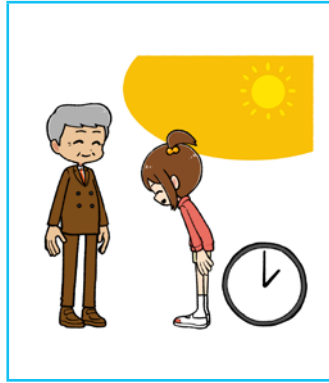

おはよう



いただきます

こんにちは

ありがとう

おはよう

ごめんなさい

ごちそうさま

こんばんは

さようなら

いろいろな あいさつ

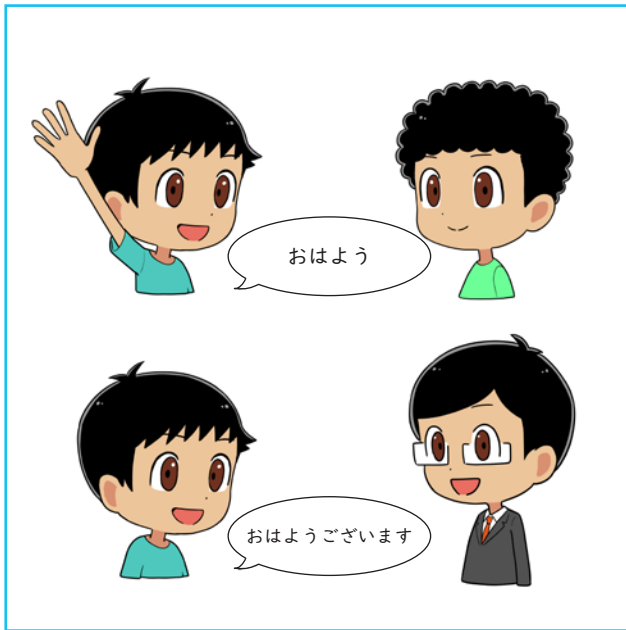

「おはよう」や「ありがとう」をおとなのひとに いうときには、「ございます」をつけて、「おはようございます」や「ありがとうございます」と います。



「ごめんなさい」や「さようなら」を ともだちに いうときには、「ごめん（ごめんね）」や「バイバイ」と います。

どちらかに ○をつけましょう



おはよう

おはようございます



おはよう

おはようございます



ありがとうございます

ありがとう



ありがとうございます

ありがとう



ごめんなさい

ごめんね



ごめんなさい

ごめんね



バイバイ

さようなら



バイバイ

さようなら

📅 🐶 できるようにしたいこと：学校の一日の流れがわかる 📅

2 がっこうのいちにち

ことばの いみを せんせいと いっしょに かくにん しましょう

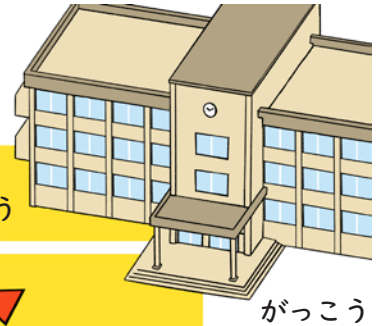

とうこう	とうこう
8:30~8:50	あさのかい
8:55~9:40	1じかんめ
9:50~10:35	2じかんめ
10:55~11:40	3じかんめ
11:50~12:35	4じかんめ
12:35~1:15	きゅうしょく
1:15~1:35	そうじ
1:35~2:00	ひるやすみ
2:00~2:45	5じかんめ
2:55~3:40	6じかんめ
3:40~3:55	かえりのかい
げこう	げこう

ほうかご	あそぶ
しゅくだい	

せんで むすびましょう

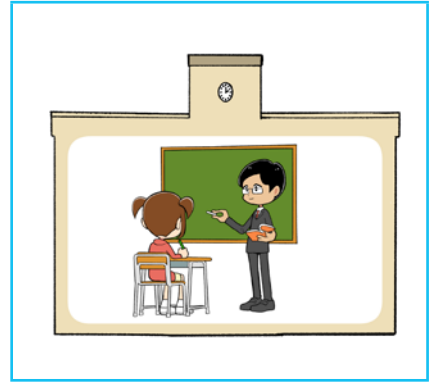
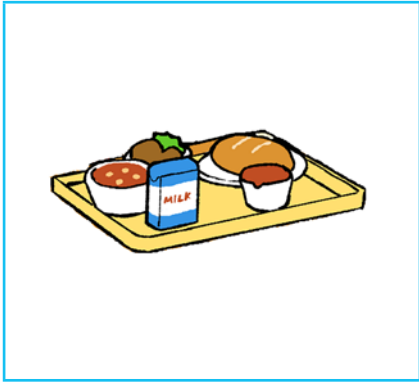

れんらくちよう

じゆぎよう

きゆうしよく

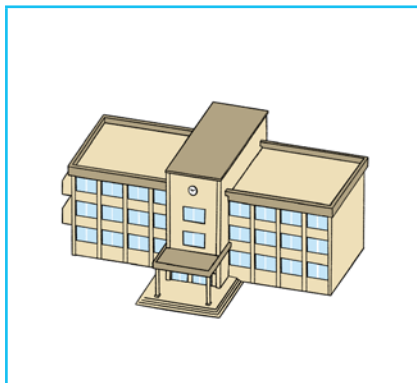

がっこう

しゆくだい

そうじ



かきましよう



かけたら、こえにだして よみましよう

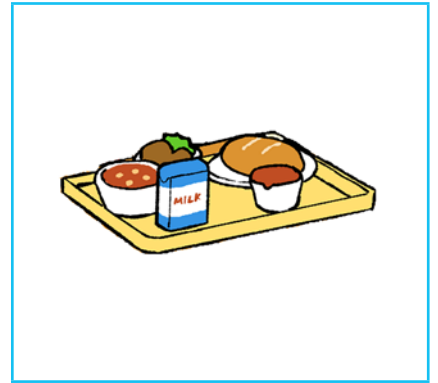
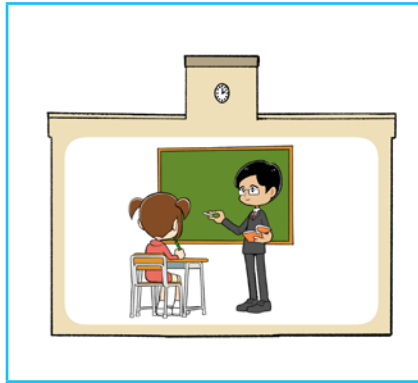
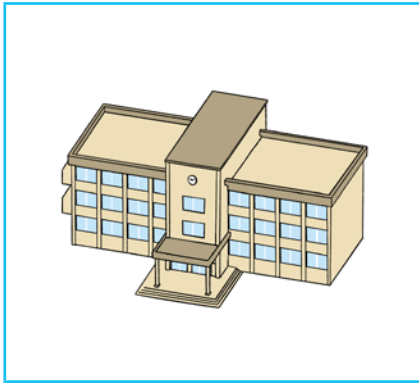

がっこう

じゅぎょう

きゅうしょく

がっこう

じゅぎょう

きゅうしょく

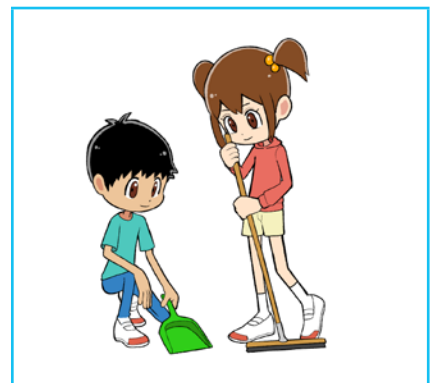

れんらくちょう

しゅくだい

そうじ

れんらくちょう

しゅくだい

そうじ



ことばを えらんで かきましょう

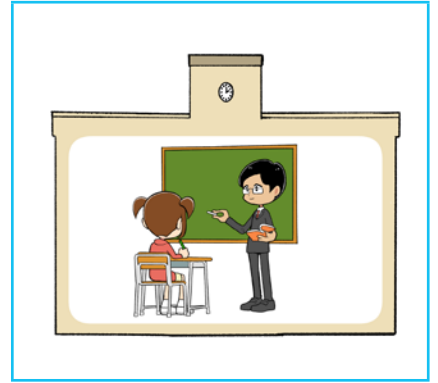

そうじ

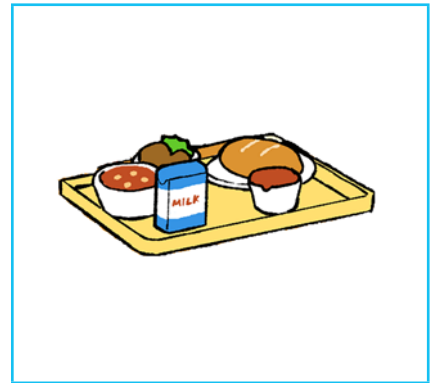
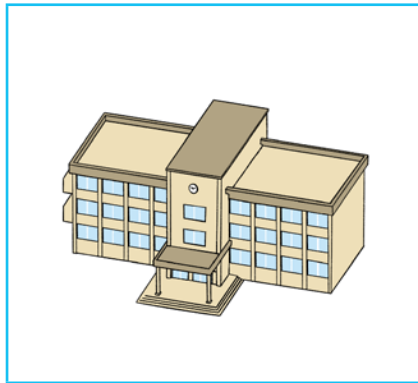

じゅぎょう

きゅうしょく

れんらくちょう

しゅくだい

そうじ

がっこう

時間の言い方を確認します。声に出して時間を読んだり、先生が言った時間を示す時計を選んだりして、練習します。

じかん・とけい

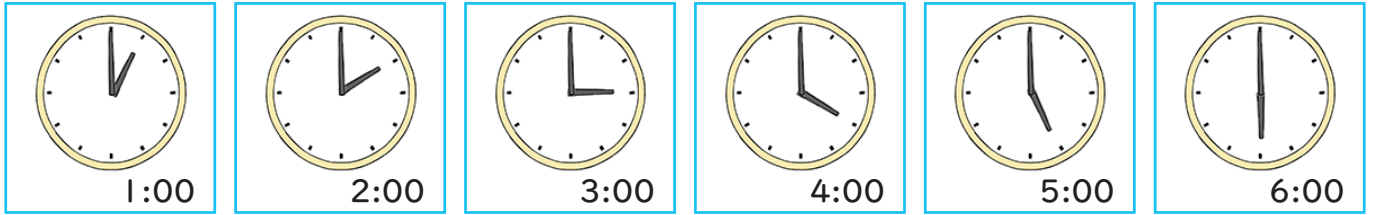

いちじ

にじ

さんじ

よじ

ごじ

ろくじ

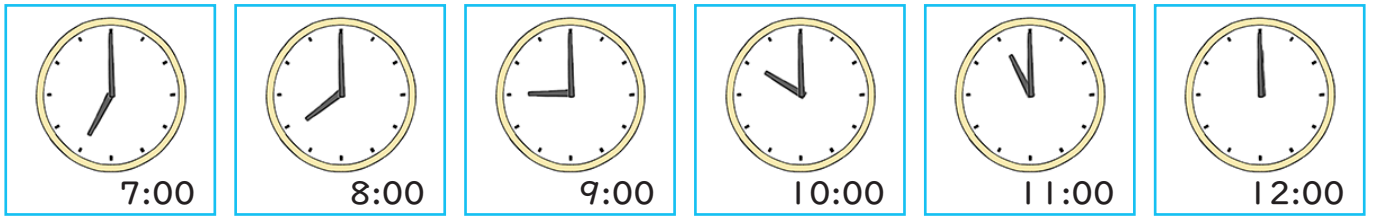

しちじ

はちじ

くじ

じゅうじ

じゅういちじ

じゅうにじ

ながいはりをよみましょう



くじごふん



くじじっぷん
じゅっぶん



くじじゅうごふん



くじにじっぷん
にじゅっぶん



くじにじゅうごふん



くじさんじっぷん
さんじゅっぶん
(くじはん)



くじさんじゅうごふん



くじよんじっぷん
よんじゅっぶん



くじよんじゅうごふん



くじごじっぷん
ごじゅっぶん

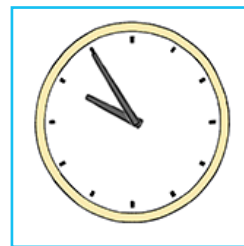

くじごじゅうごふん



なんじか わかるかな？

先生が声に出して、読んでください。子どもは、先生に言われた時間を数字か時計で答えます。

れい



あさのかいは はちじはん からです。



8 : 30



学校の一日の予定にあわせて先生が作問してください。

①



は からです。



:

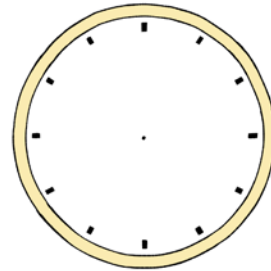

②



は からです。



:

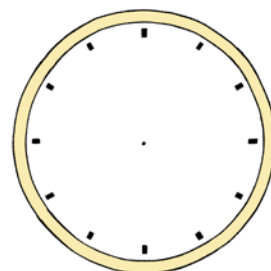

👤 できるようにしたいこと：学校で使う持ち物の名前を知り、学校の準備ができる 📊

3 ふくそう・もちもの

ことばの いみを せんせいと いっしょに かくにんしましょう

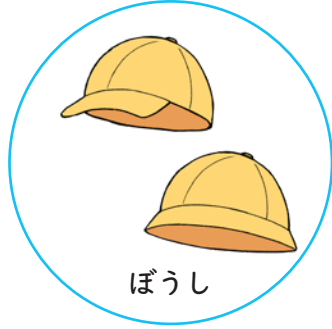

せんて むすびましよう

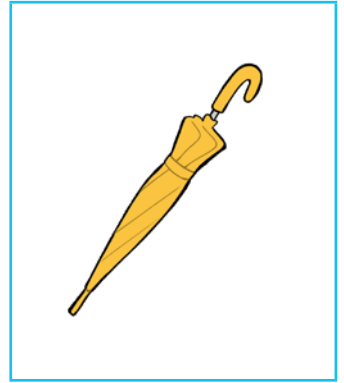
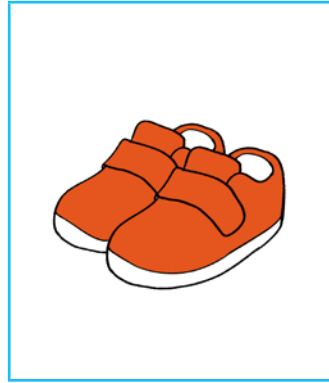
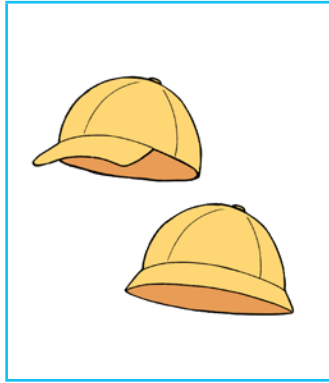
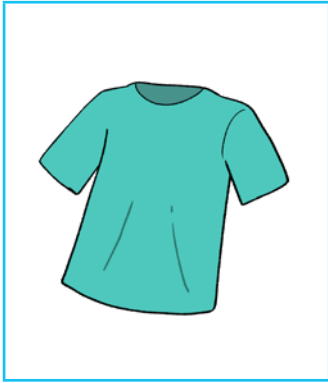

くつ

かさ

ぼうし

シャツ

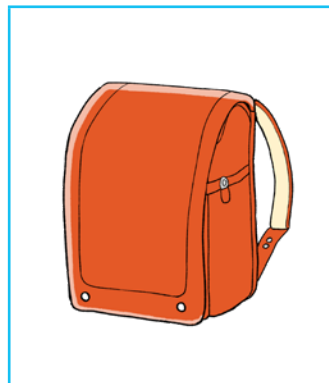
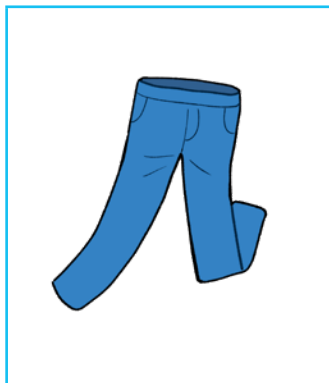

ズボン

スカート

ランドセル

なふだ



かきましよう



かけたら、こえにだして よみましよう

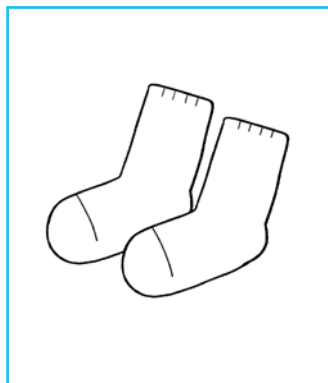
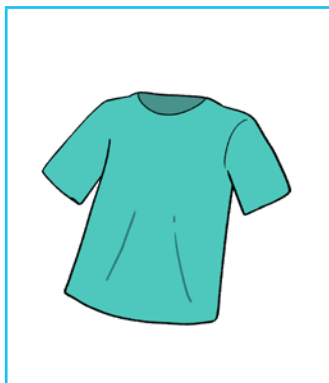
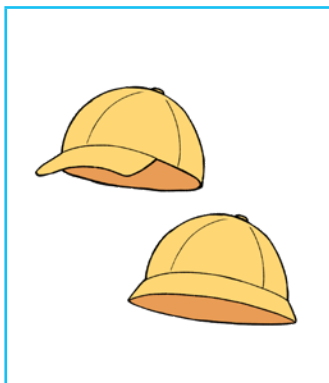

ぼうし

シャツ

くつした

ランドセル

ぼうし

シャツ

くつした

ランドセル

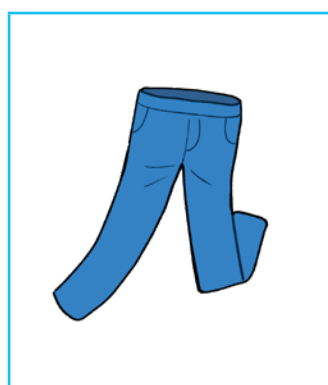
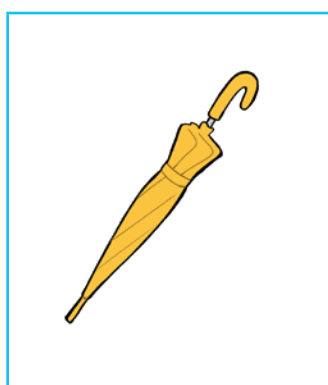
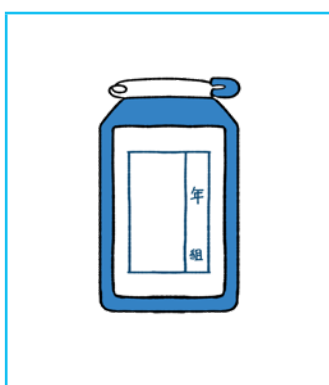
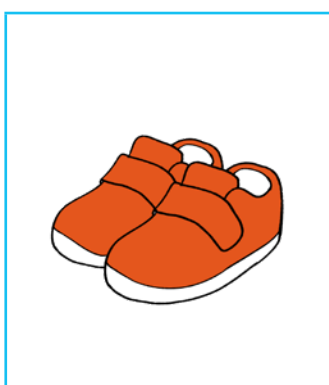
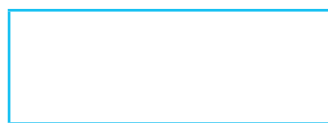
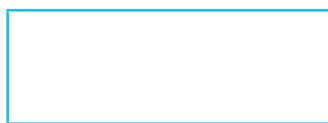
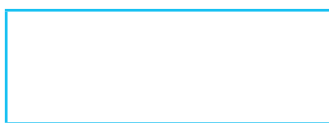
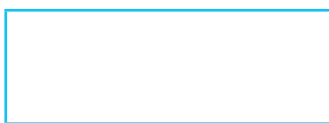

くつ

なふだ

かさ

ズボン

くつ

なふだ

かさ

ズボン

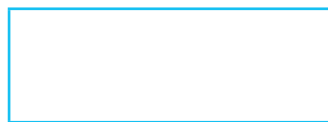
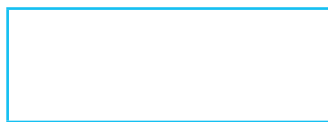
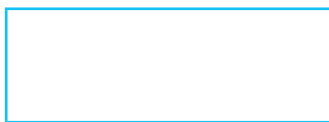



ことばを えらんで かきましょう

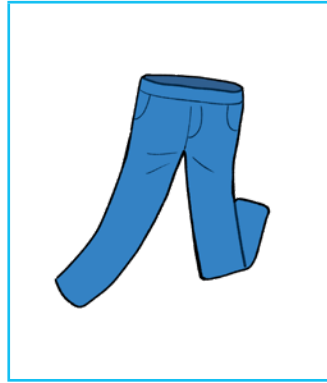
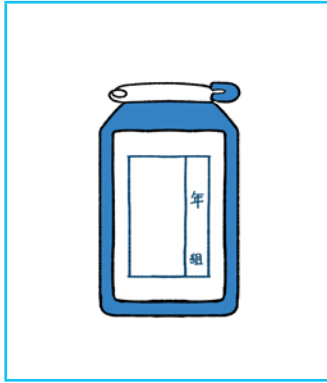
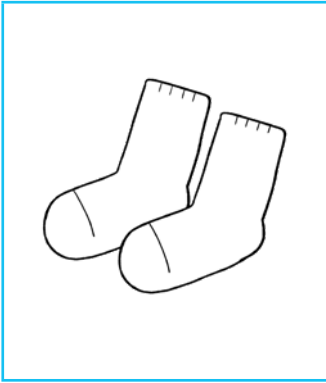

くつした

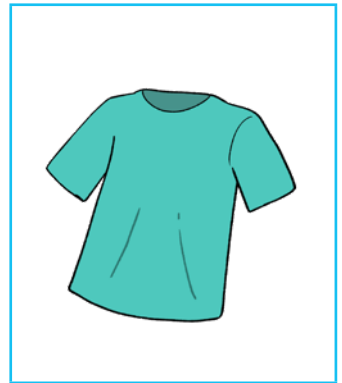
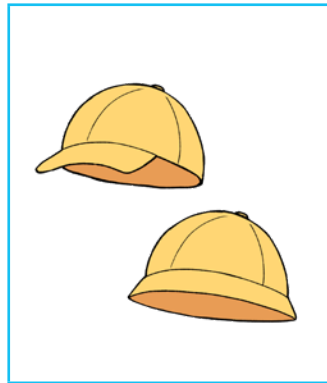
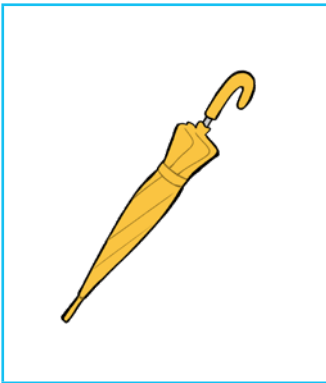

スカート

シャツ

かさ

なふだ

くつ

ぼうし

くつした

ズボン

ことばの いみを せんせいといっしょにかくにんしましょう

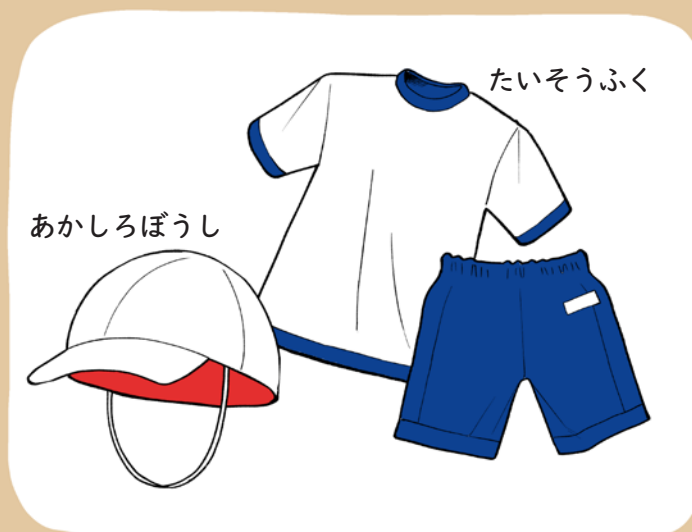
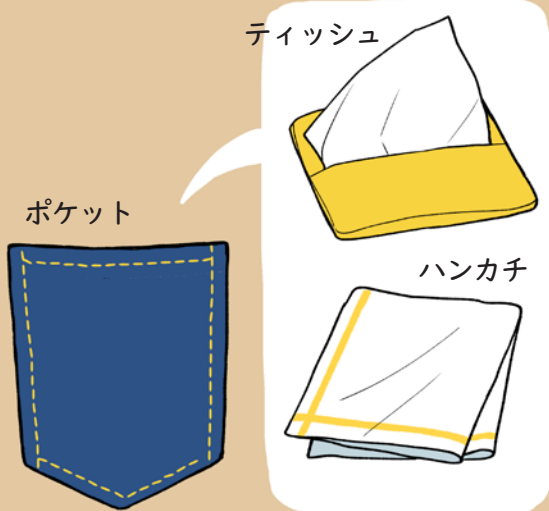

せんで むすびましょう

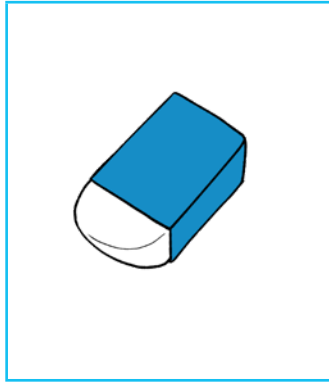

けしゴム

たいそうふく

れんらくちょう

うわばき

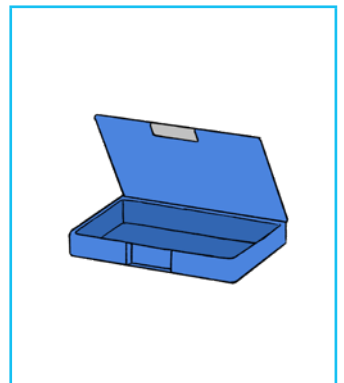
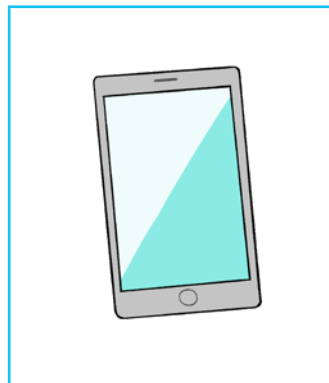
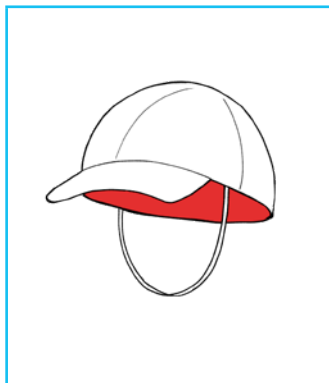

あかしろぼうし

ふでばこ

タブレット

きょうかしよ



かきましよう



かけたら、こえにだして よみましよう

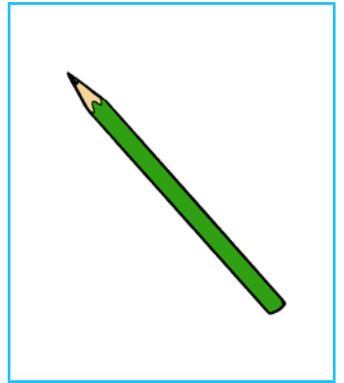
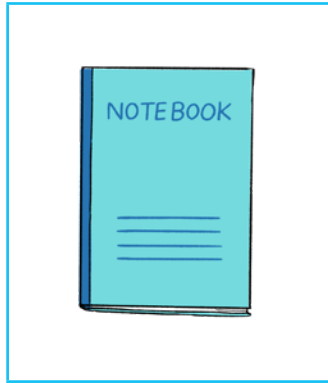
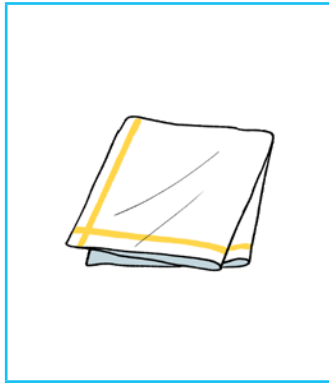
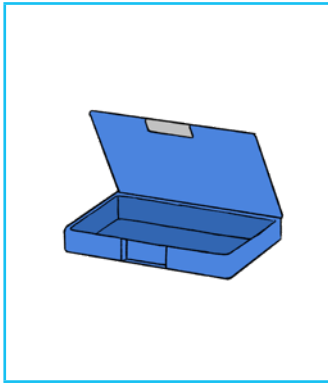

ふでばこ

ハンカチ

ノート

えんぴつ

ふでばこ

ハンカチ

ノート

えんぴつ

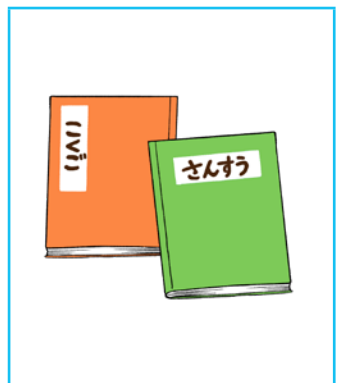
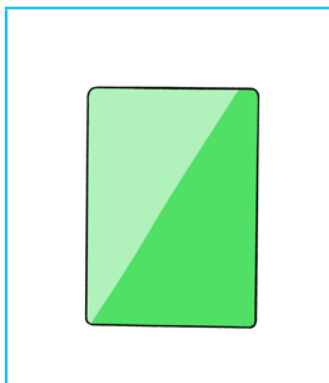
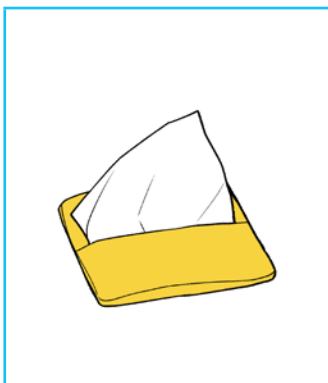
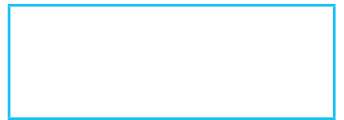
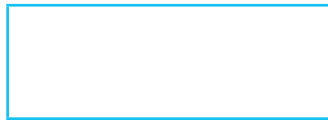
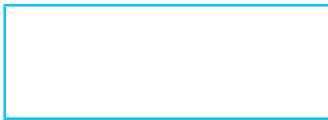

ティッシュ

したじき

たいそうふく

きょうかしょ

ティッシュ

したじき

たいそうふく

きょうかしょ

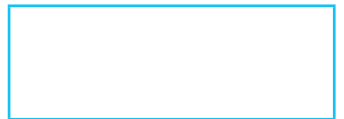
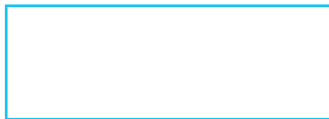



ことばを えらんで かきましょう

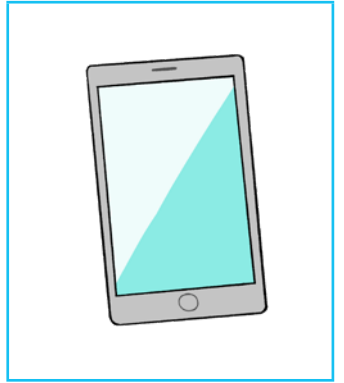
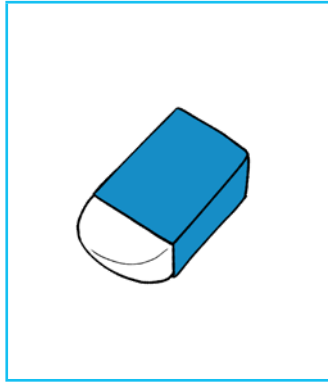
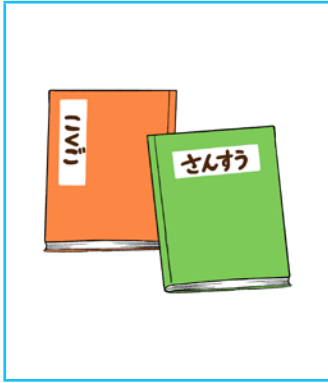

きょうかしよ

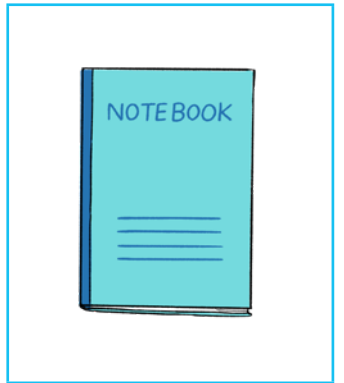
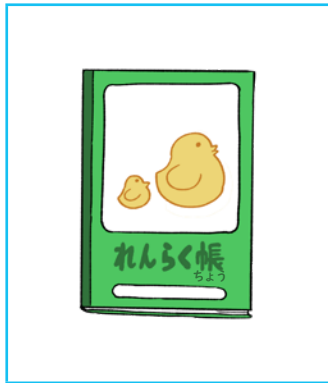
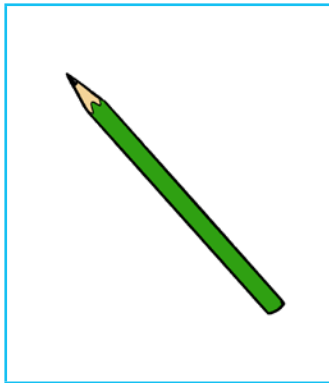
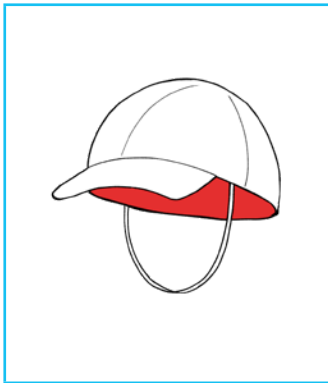

ノート

あかしろぼうし

けしゴム

きょうかしよ

タブレット

れんらくちよう

えんぴつ

うわばき

先生が言ったことばがあらわすものを丸でかこみます。

ききとりましょう①

れい



かさ

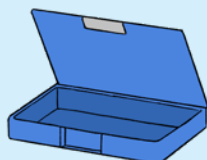
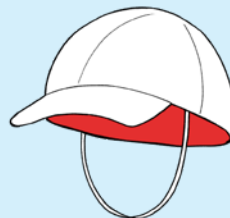
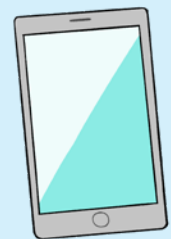
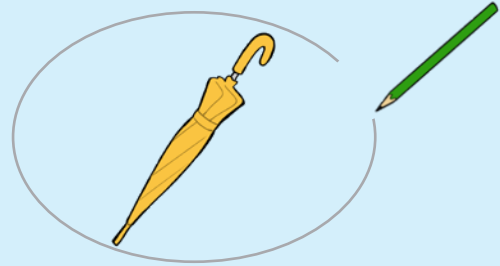

ききとりましょう②

れい



うわばき

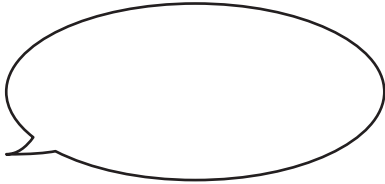
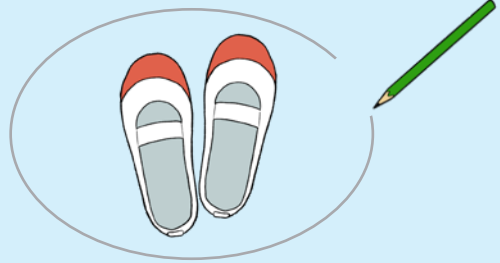

できるようにしたいこと：学校にある施設や教室、先生の名前がわかる

4 がっこう

ことばの いみを せんせいと いっしょにかくにんしましょう

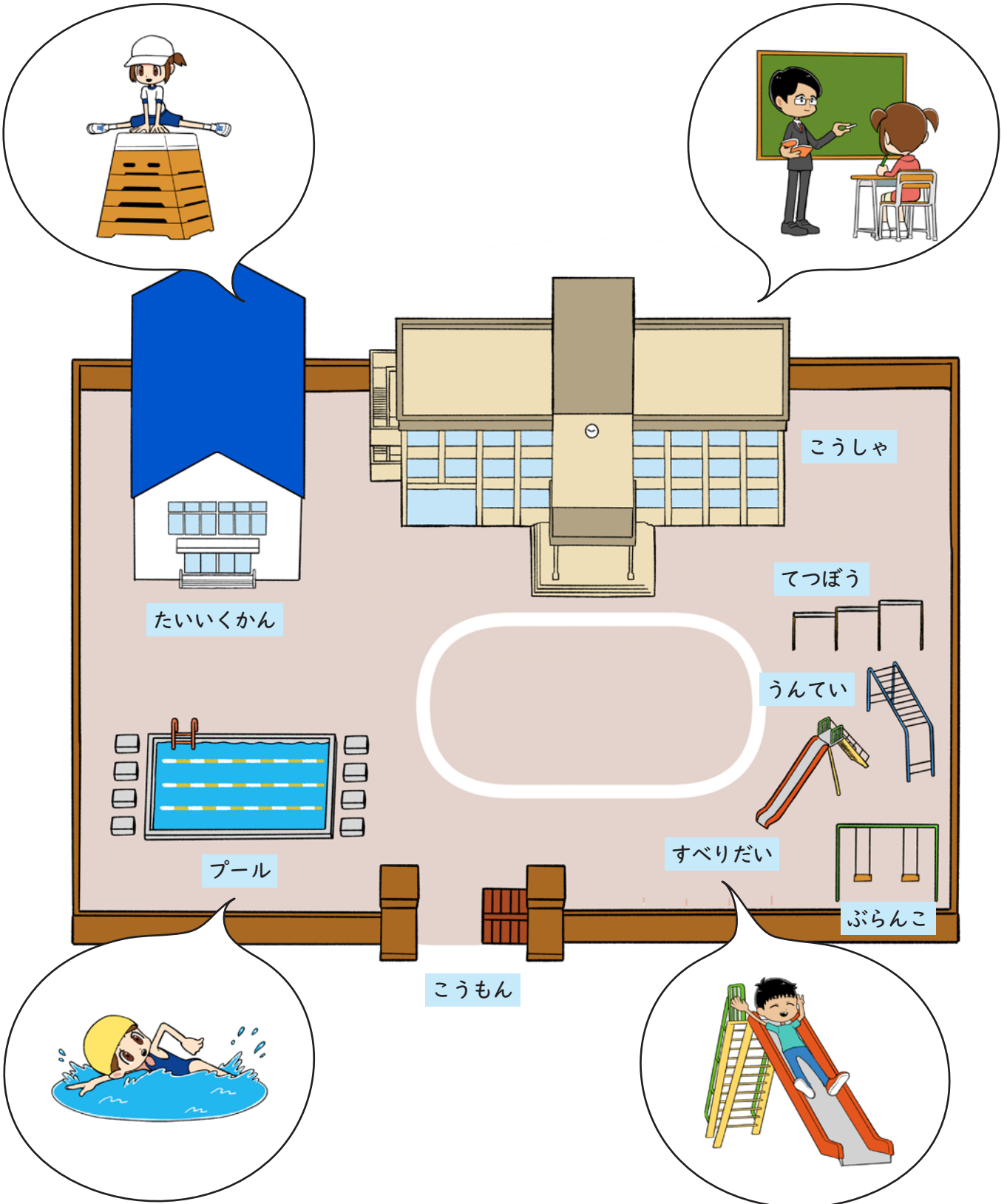

せんで むすびましょう

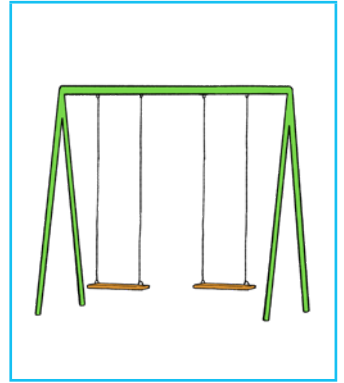
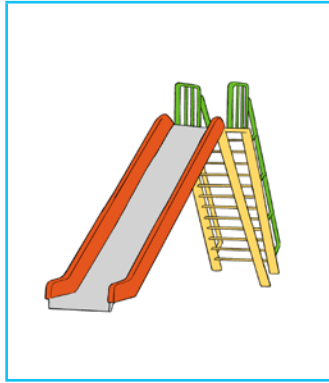
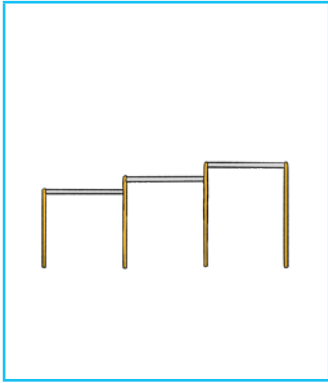

うんてい

てつぼう

ぶらんこ

すべりだい

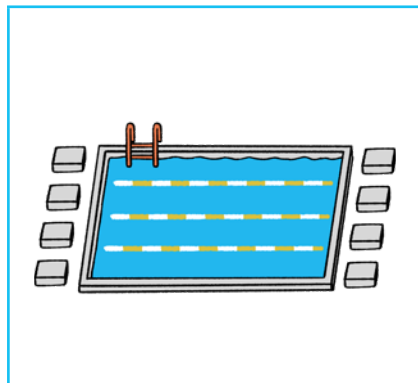
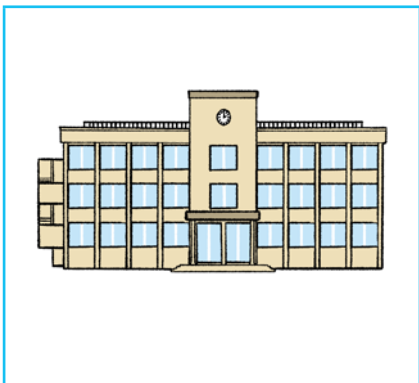

プール

たいいくかん

こうしゃ



かきましよう



かけたら、こえにだして よみましよう

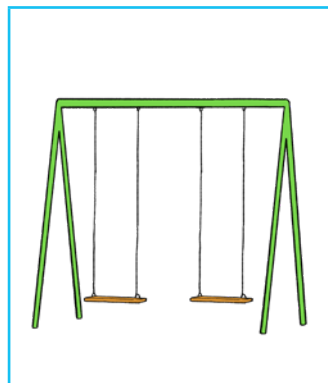
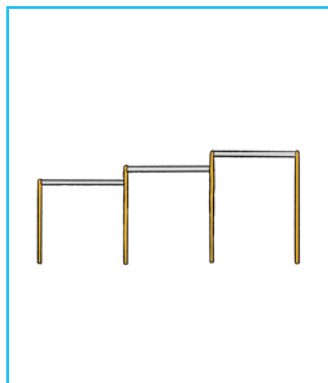
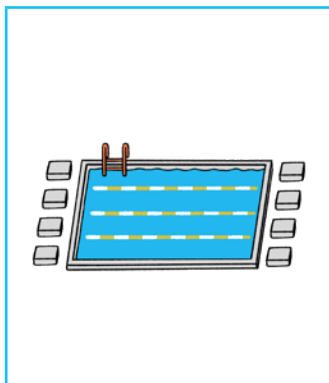
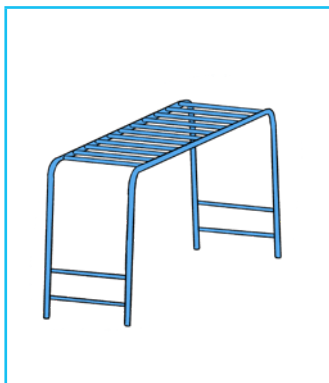

うんてい

プール

てつぼう

ぶらんこ

うんてい

プール

てつぼう

ぶらんこ

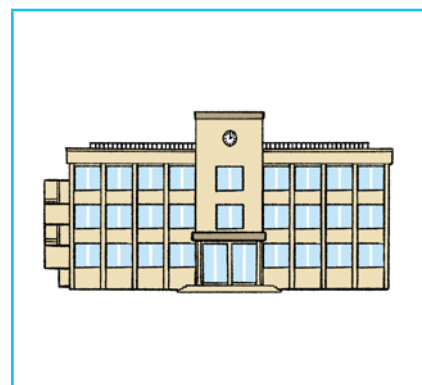
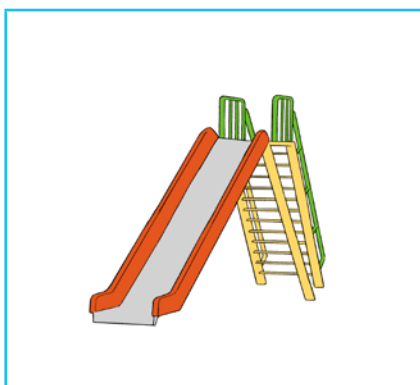
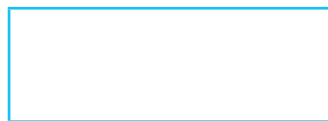
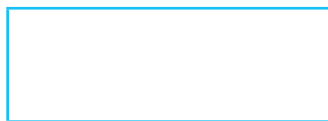
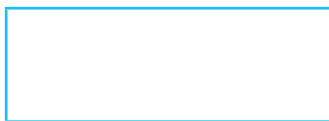
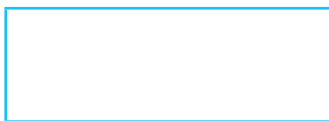

すべりだい

たいいくかん

こうしゃ

すべりだい

たいいくかん

こうしゃ

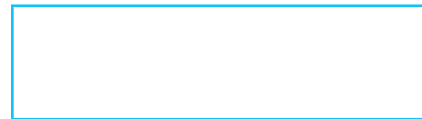
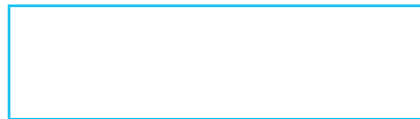
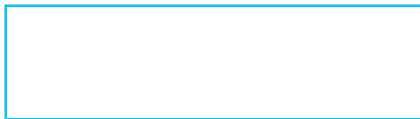



ことばを えらんで かきましょう

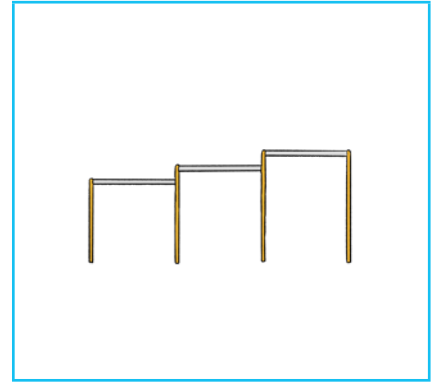
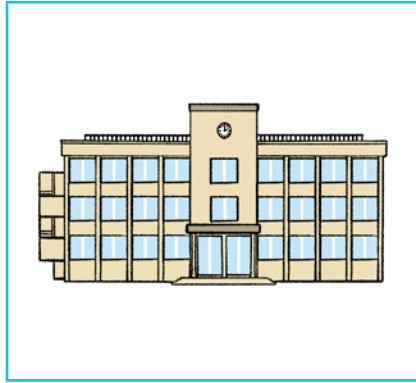
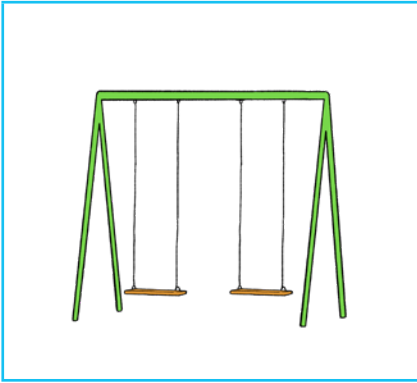

ぶらんこ

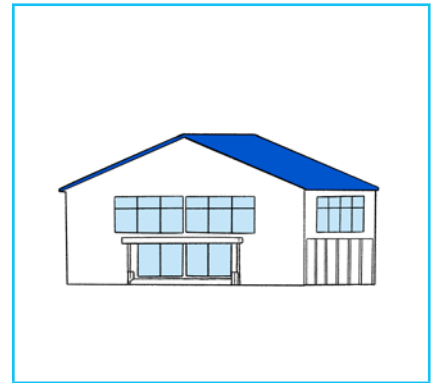
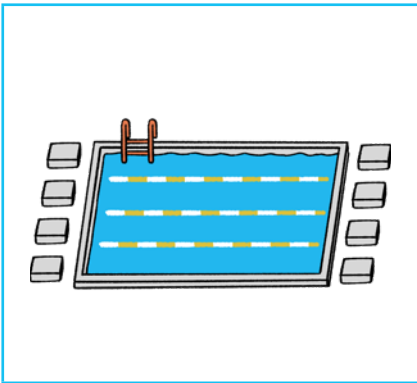

たいいくかん

プール

ぶらんこ

てつぼう

こうしゃ

うんてい

こうしゃのなか

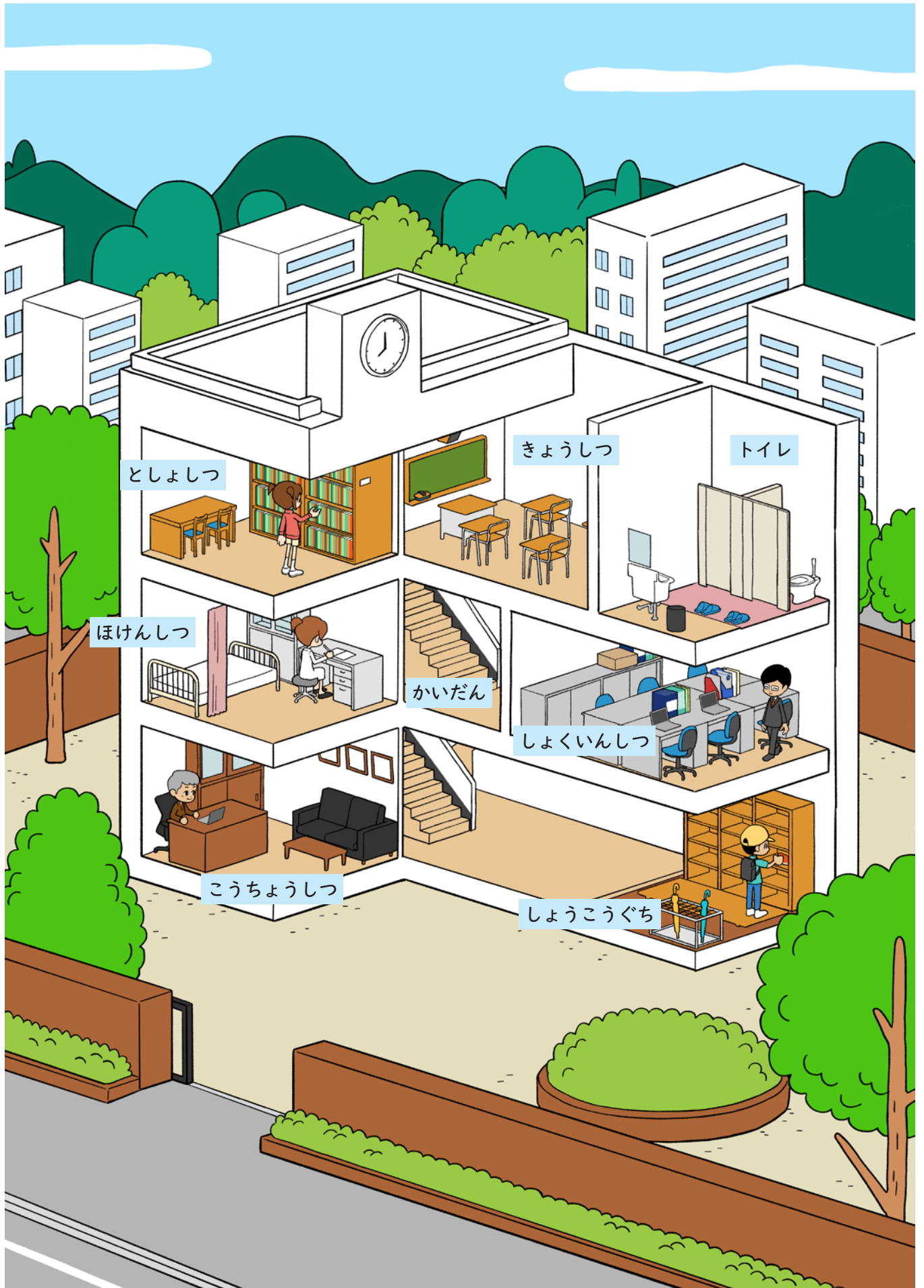

せんで むすびましょう

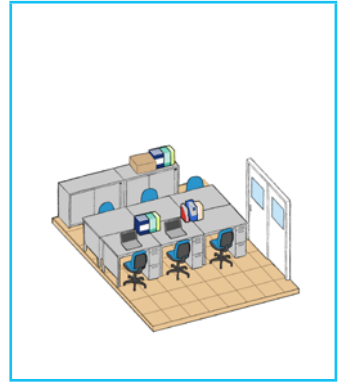
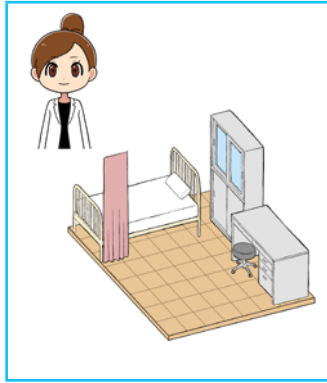

しょくいんしつ

きょうしつ

ほけんしつ

こうちょうしつ

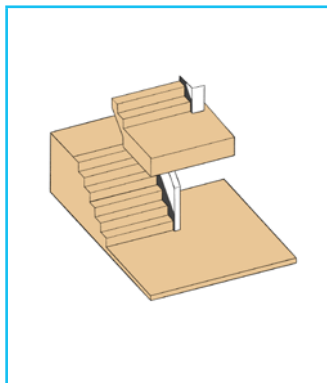
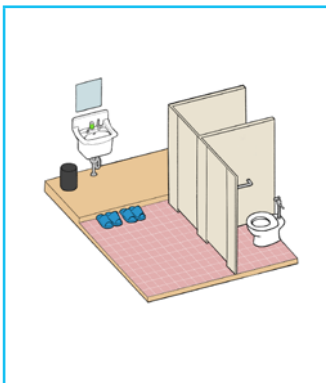

かいだん

としょしつ

トイレ

しょうこうぐち



かきましよう



かけたら、こえにだして よみましよう

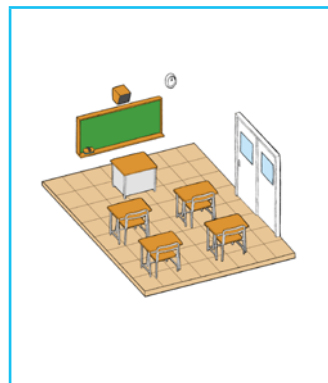
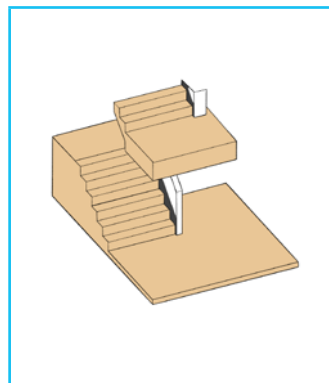
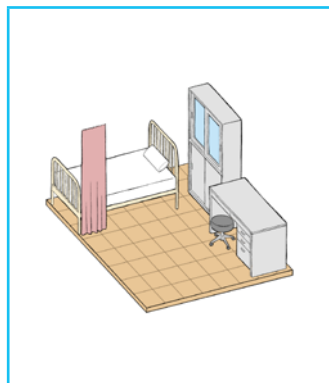
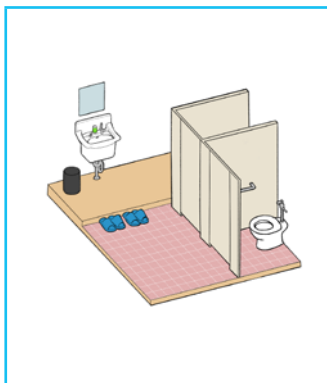

トイレ

ほけんしつ

かいだん

きょうしつ

トイレ

ほけんしつ

かいだん

きょうしつ

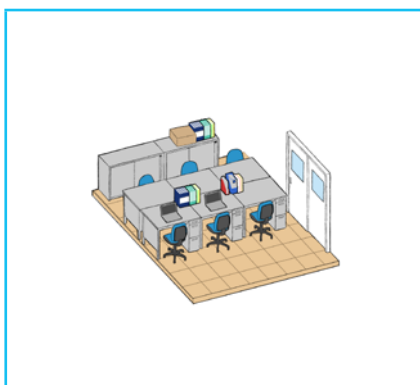
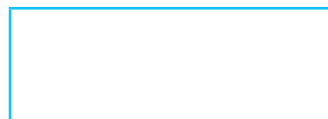
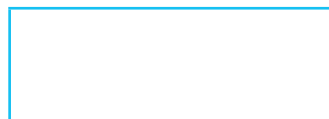
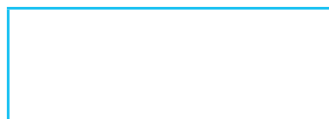
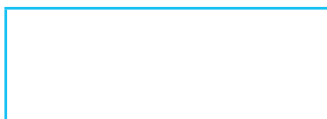

しょくいんしつ

としょしつ

こうちょうしつ

しょくいんしつ

としょしつ

こうちょうしつ

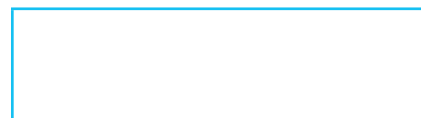
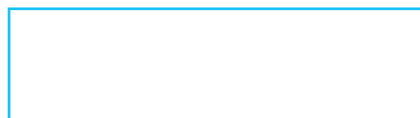
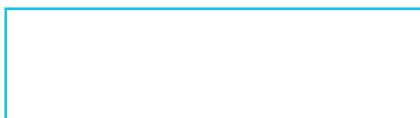



ことばを えらんで かきましょう

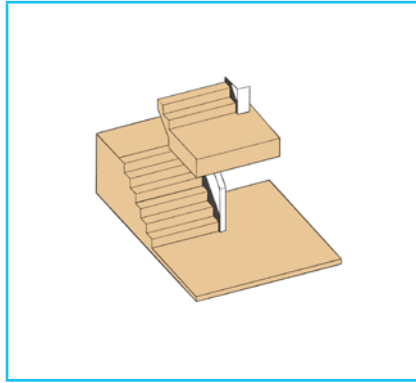
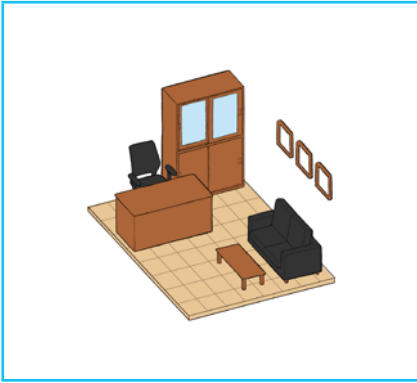

こうちょうしつ

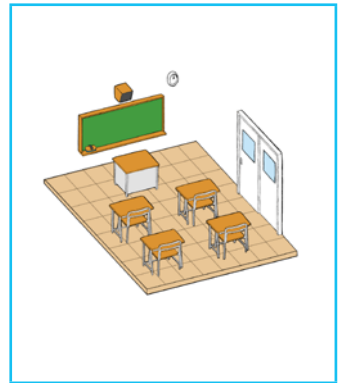
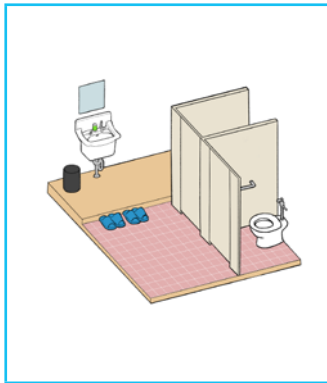
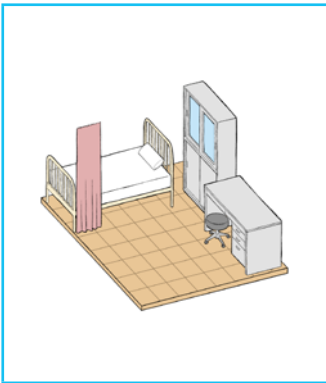

ほけんしつ

としょしつ

しょくいんしつ

きょうしつ

こうちょうしつ

かいだん

トイレ

校長室や保健室や職員室に行って、先生にインタビューをします。

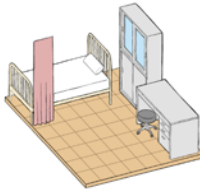

こうちょうせんせい

ほけんのせんせい

たんにんのせんせい

がっこうのなかを たんけんしましょう

○こうちょうしつに いってみましょう

・こうちょうせんせいの なまえ



()

・すきな たべもの

()



せんせいの がおえや
せんせいの すきな
たべもの えを かいてね。

○ほけんしつに いってみましょう

・ほけんのせんせいの なまえ

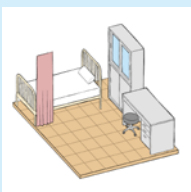

()

・すきな たべもの

()

○しょくいんしつに いってみましょう

・せんせいの なまえ



()

・すきな たべもの

()

あなたのくにのがっこうにあるものに○をつけましょう

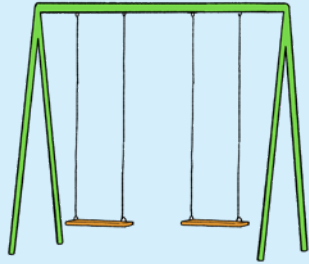

ぶらんこ

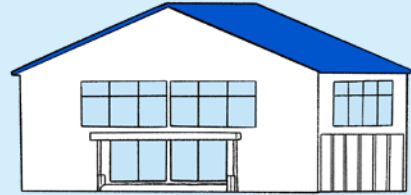

たいいくかん

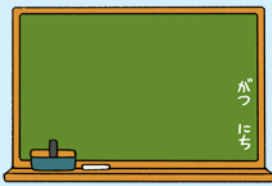

こくばん



カフェテリア/しょくどう

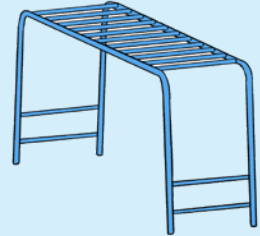

うんてい



スクールバス

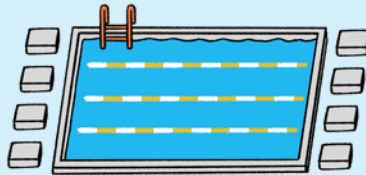

プール

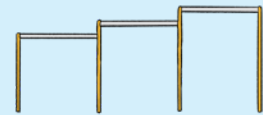

てつぼう



そうじどうぐいれ



とびばこ



なふだ



ランドセル



ばいてん

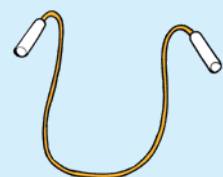

なわとび

👤 できるようにしたいこと：教室にあるものの名前がわかる

5 きょうしつ

ことばの いみを せんせいと いっしょに かくにんしましょう

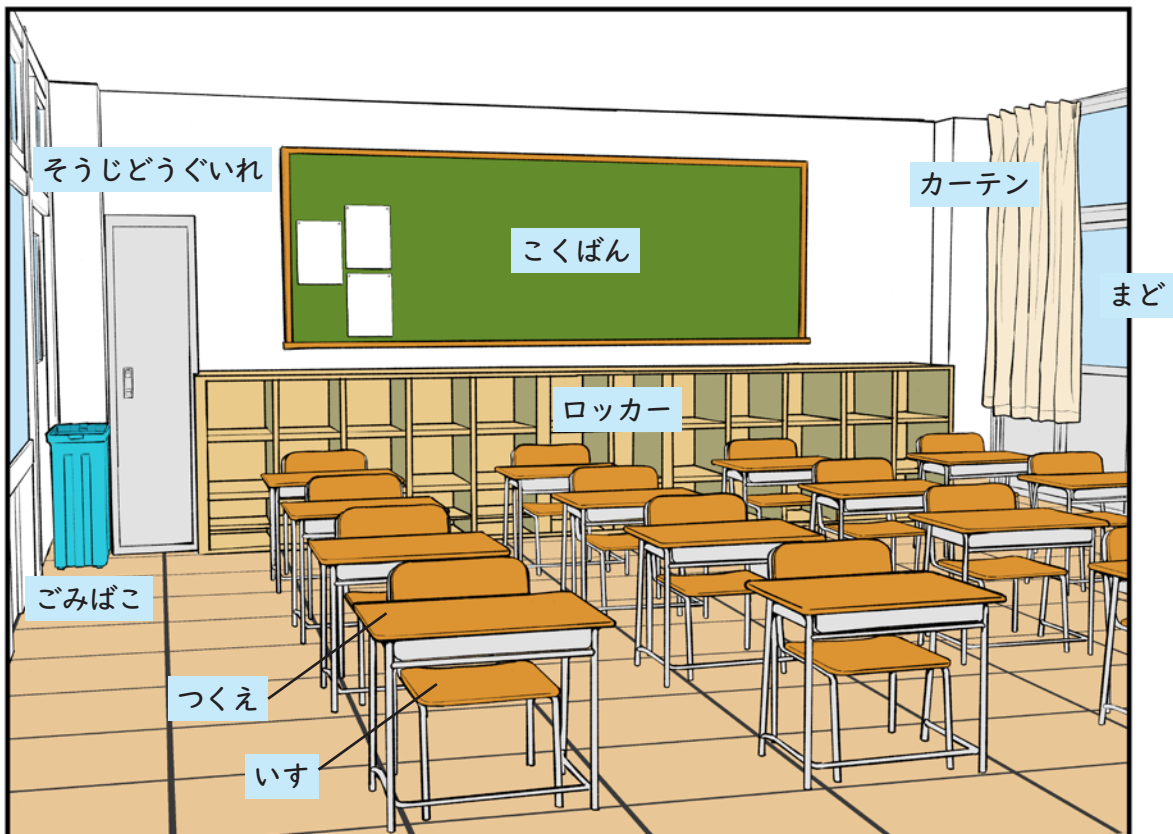
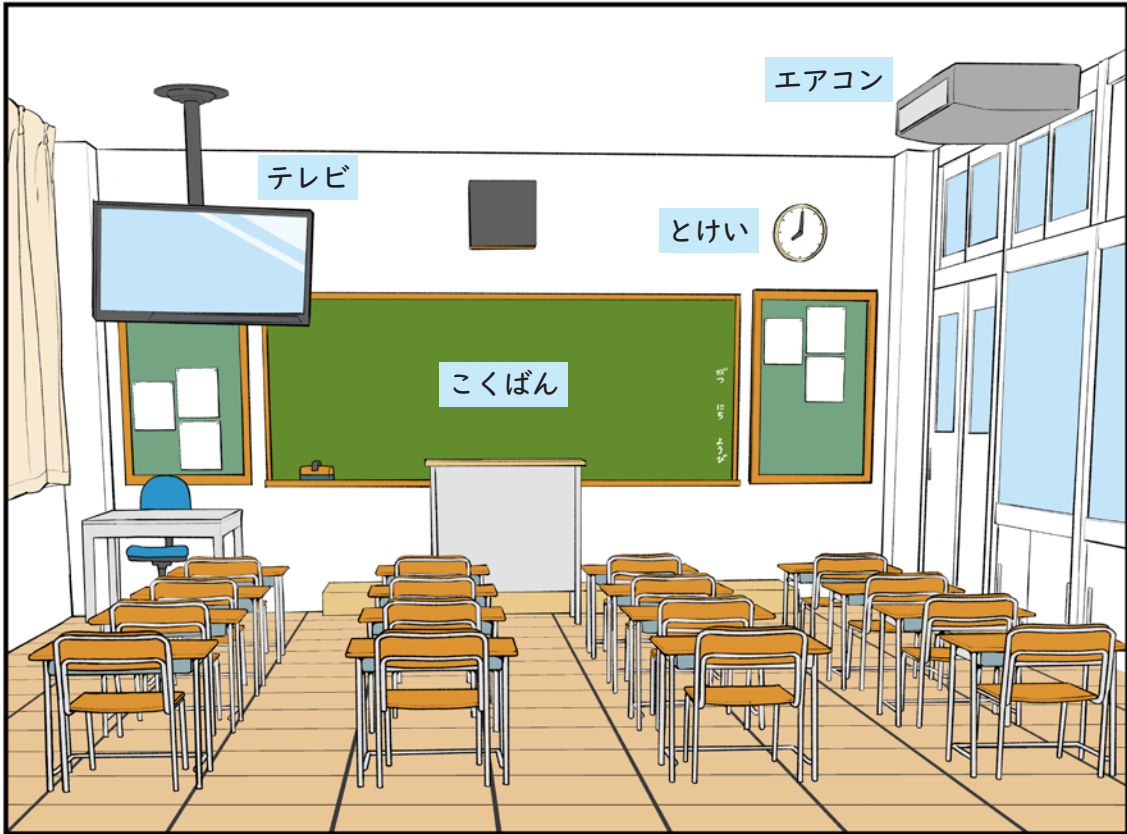

せんで むすびましょう

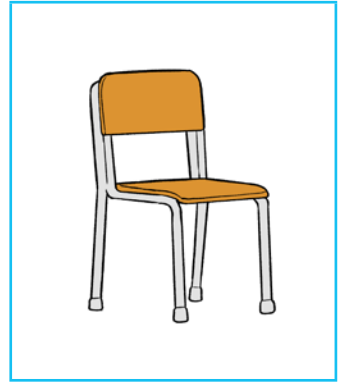
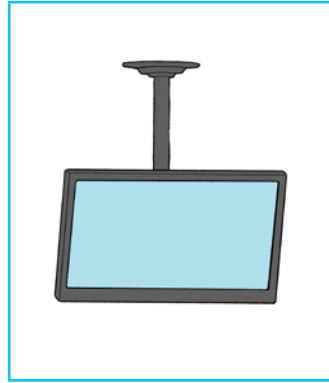
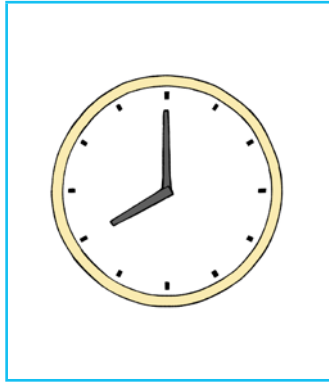
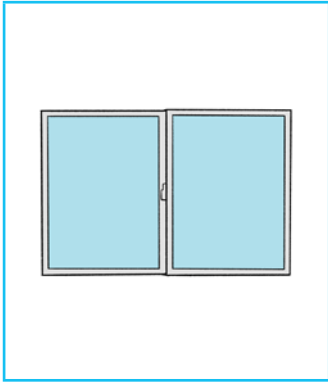

いす

とけい

まど

テレビ

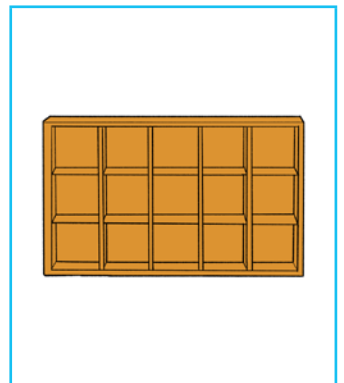
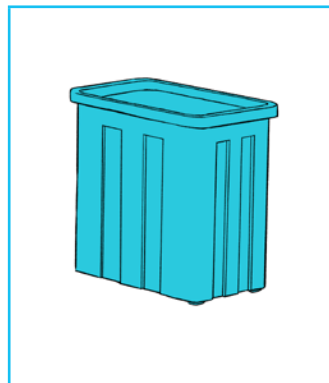
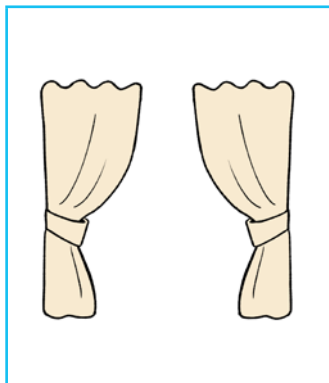

ごみばこ

ロッカー

つくえ

カーテン



かきましょう



かけたら、こえにだして よみましょう

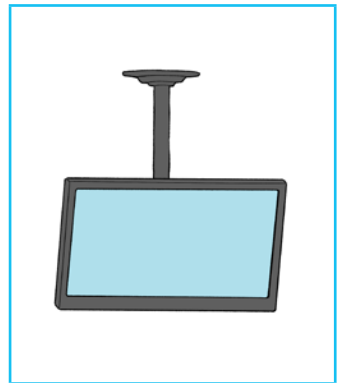
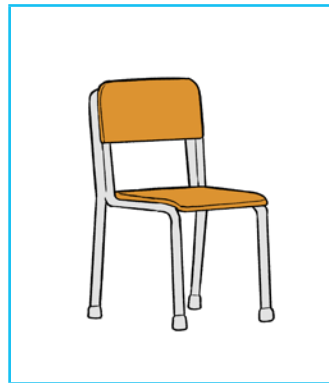
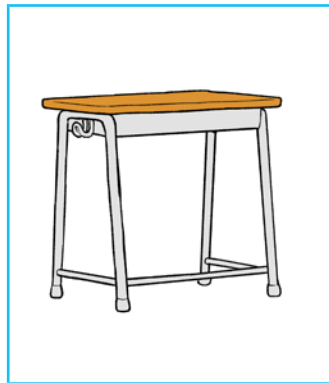
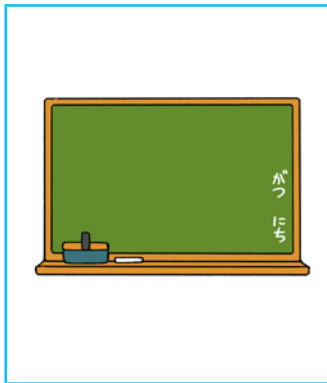

こくばん

つくえ

いす

テレビ

こくばん

つくえ

いす

テレビ

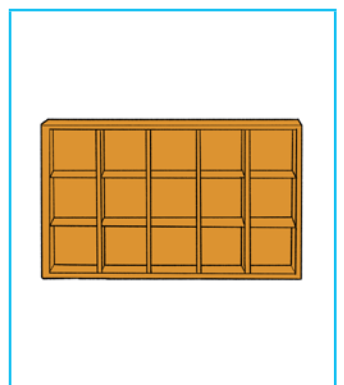
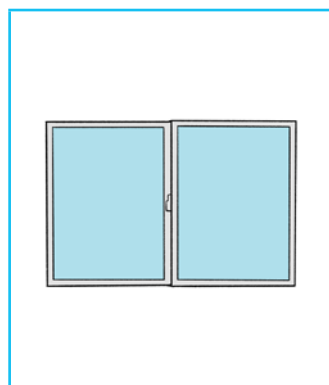
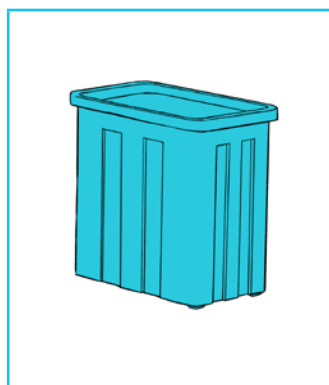

とけい

ごみばこ

まど

ロッカー

とけい

ごみばこ

まど

ロッカー



ことばを えらんで かきましょう

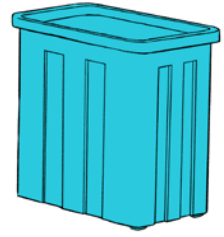

とけい

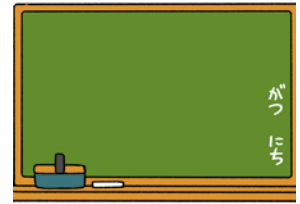
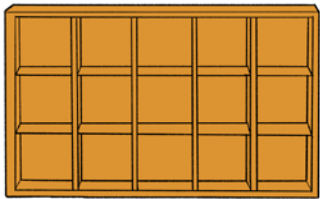

いす

ロッカー

こくばん

つくえ

ごみばこ

とけい

違うところを指でさしたり、丸をつけたりしたあと、どこが違うのか、勉強したことばを使って説明します。

まちがいさがし①

うえの きょうしつと したの きょうしつの ちがいを 5つ みつけましょう

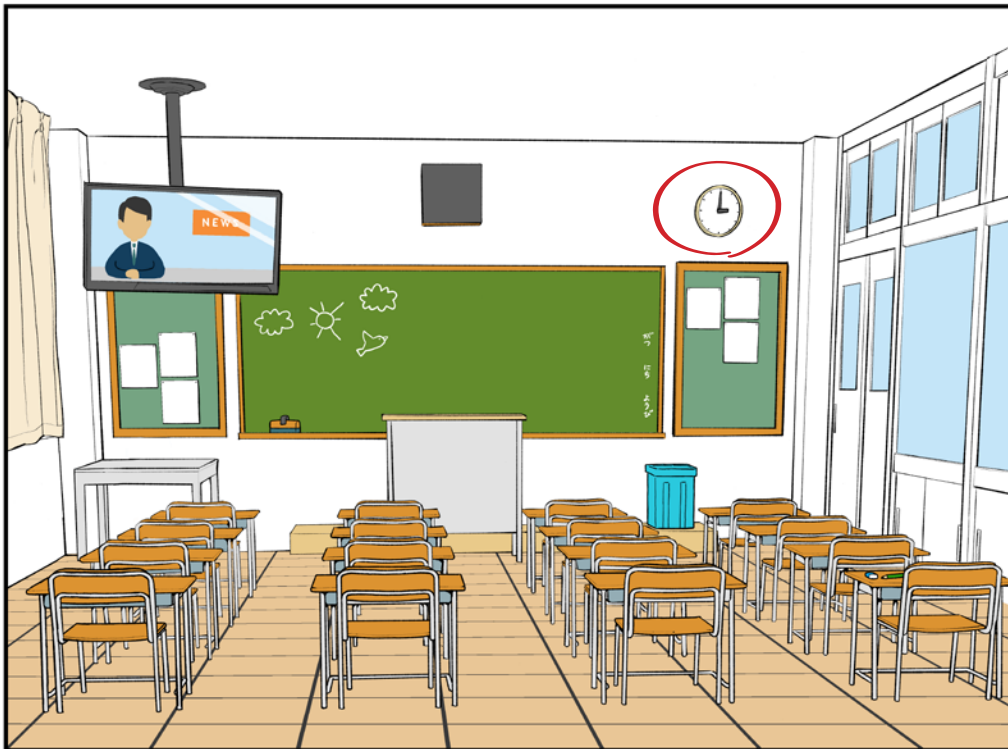
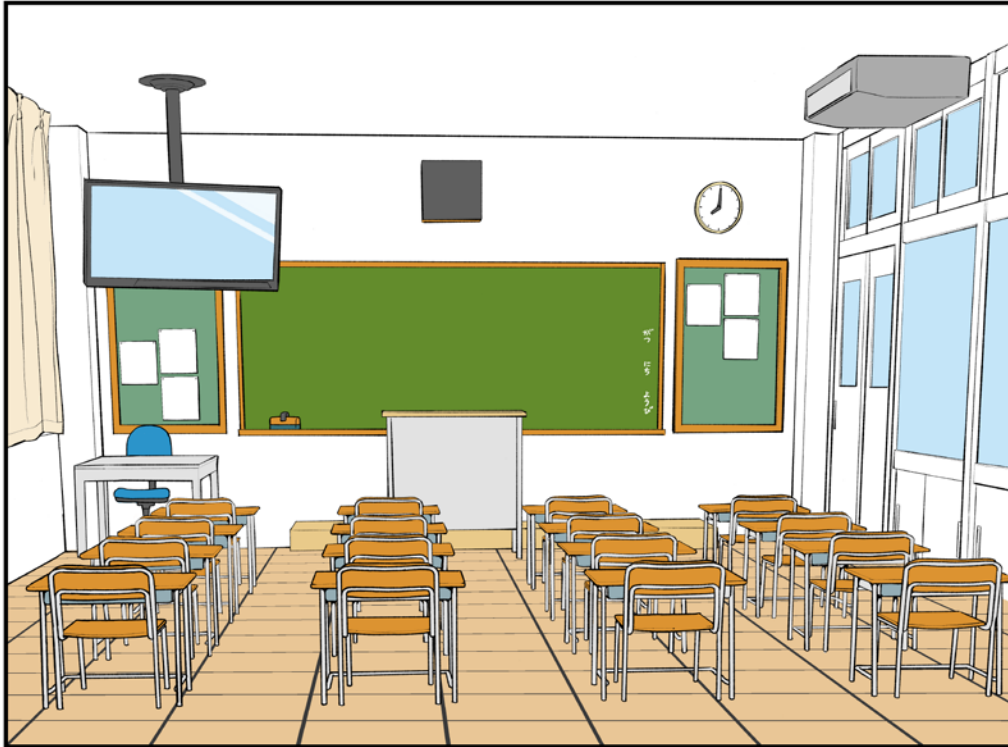

【れい】
とけいが ちがいます。
うへは8じ、したは3じです。

【れい】のほかに
5つあるよ。



まちがいさがし②

うえの きょうしつと したの きょうしつの ちがいを 5つ みつけましょう

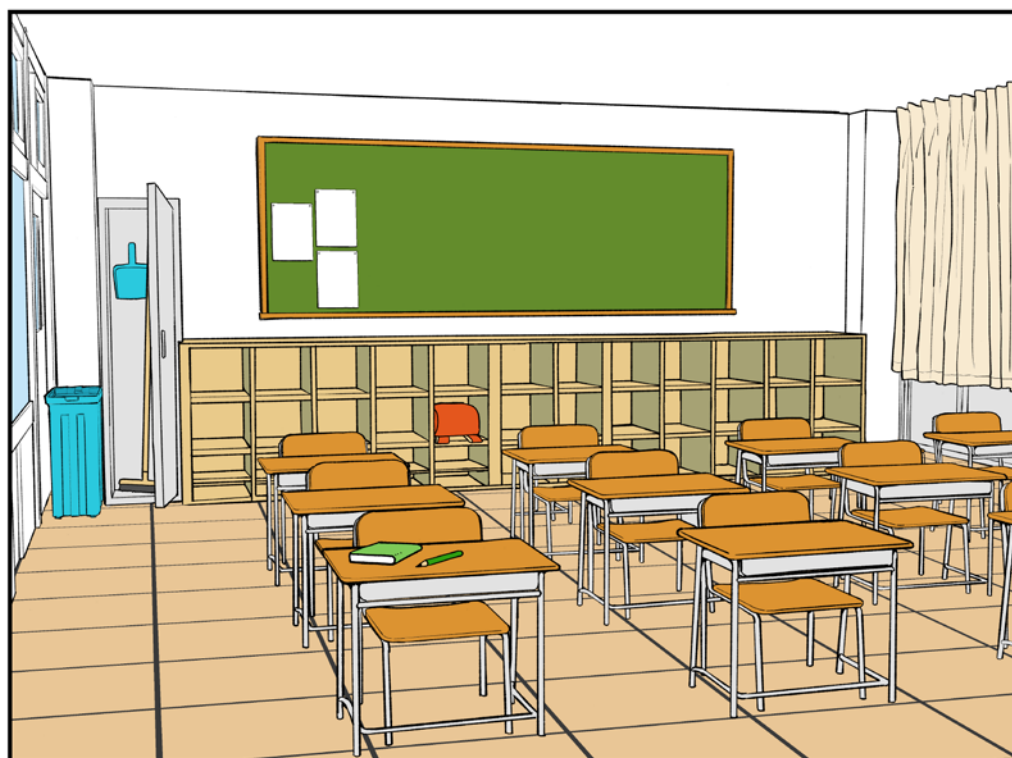
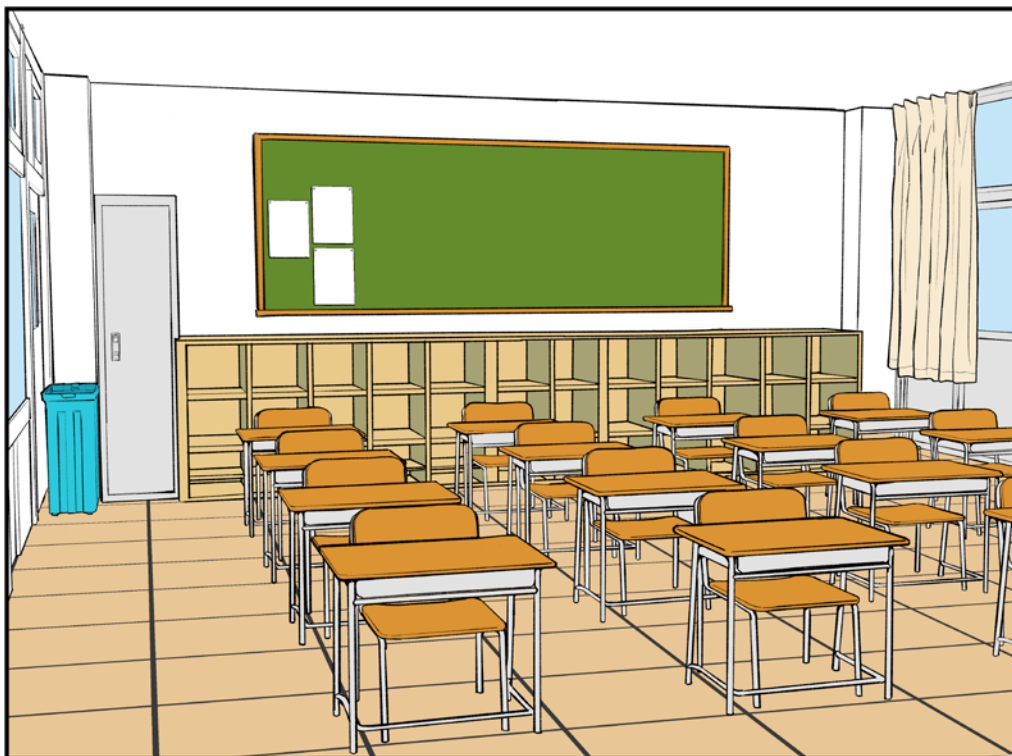

まちがいさがしの
こたえは
さいごの ページに あるよ。

できるよにしたいこと：時間割にあわせて、授業の準備ができる

6 べんきょう

ことばの いみを せんせいといっしょにかくにんしましょう



じゅぎょう



きょうかしょ

	げつ	か	すい	もく	きん
1	こくご	ずこう	さんすう	さんすう	こくご
2	さんすう	ずこう	しゃかい	こくご	おんがく
3	りか	こくご	たいいく	りか	たいいく
4	しゃかい	こくご	がいこくご	おんがく	さんすう
5	そうごう	さんすう	こくご	たいいく	がっかつ
6		どうとく	りか		そうごう

じかんわり

おんどく

漢

かんじ

こくご

じっけん

かんさつ

りか

ちず

けんがく

しゃかい

かたち

けいさん

さんすう

Hello

えいご

Hello

がいこくご

どうとく

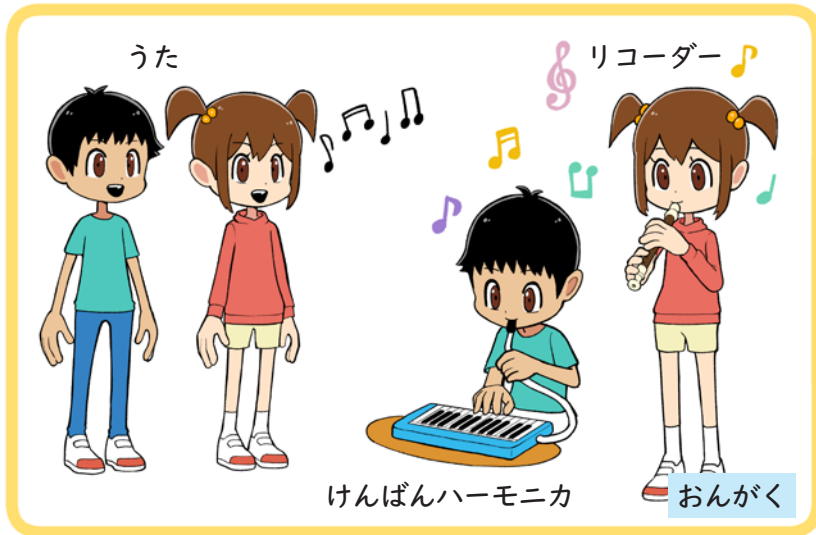
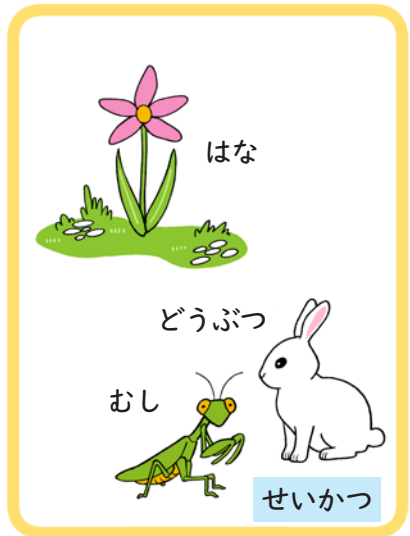
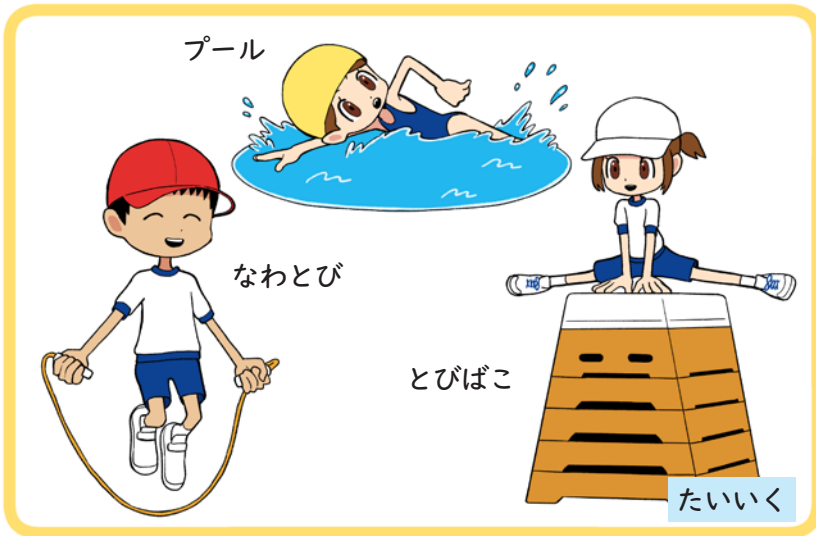

あいう
えお

ひらがな

アイウ
エオ

かたかな

牛
昼 黒
声

かんじ

1 2
4 3 5 6

すうじ



しゅくだい

せんで むすびましょう

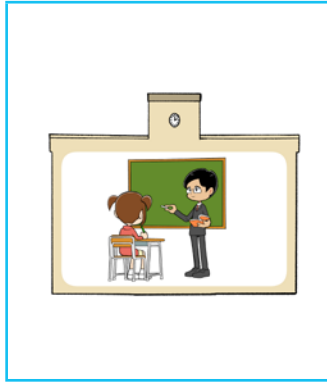
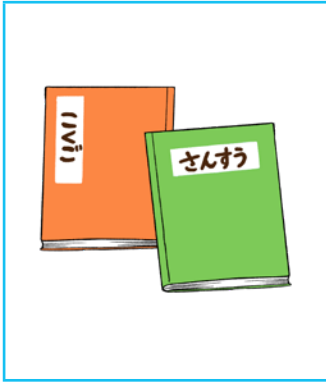

じかんわり 3ねん1くみ

	げつ	か	すい	むく	きん
1	こくご	ずごう	さんすう	さんすう	こくご
2	さんすう	ずごう	しゃかい	こくご	おんがく
3	りか	こくご	たいいく	りか	たいいく
4	しゃかい	こくご	かいこご	おんがく	さんすう
5	そうごう	さんすう	こくご	たいいく	がっかつ
6	どうとく	りか			そうごう



しゅくだい

じかんわり

きょうかしょ

じゅぎょう

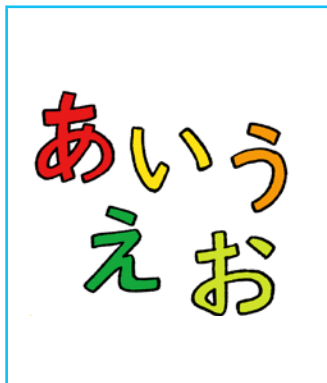
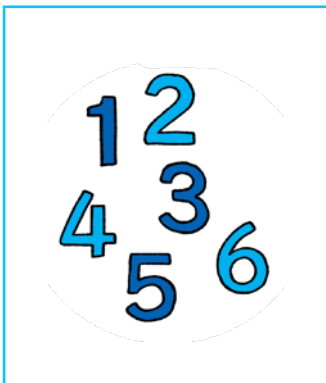

かんじ

すうじ

かたかな

ひらがな



ことばを えらんで かきましょう

じかんわり 3ねん1くみ					
	げつ	か	すい	もく	きん
1	こくご	ずこ	さんすう	さんすう	こくご
2	さんすう	ずこ	しゃかい	こくご	おんがく
3	りか	こくご	たいいく	りか	たいいく
4	しゃかい	こくご	おんがく	さんすう	さんすう
5	そうごう	さんすう	こくご	たいいく	がっかつ
6		どうとく	りか		そうごう



じかんわり

アイウ
エオ

12
3
456

牛
黒
昼
声

あいう
えお

じゅぎょう

しゅくだい

きょうかしょ

じかんわり

ひらがな

かたかな

かんじ

すうじ

せんて むすびましよう

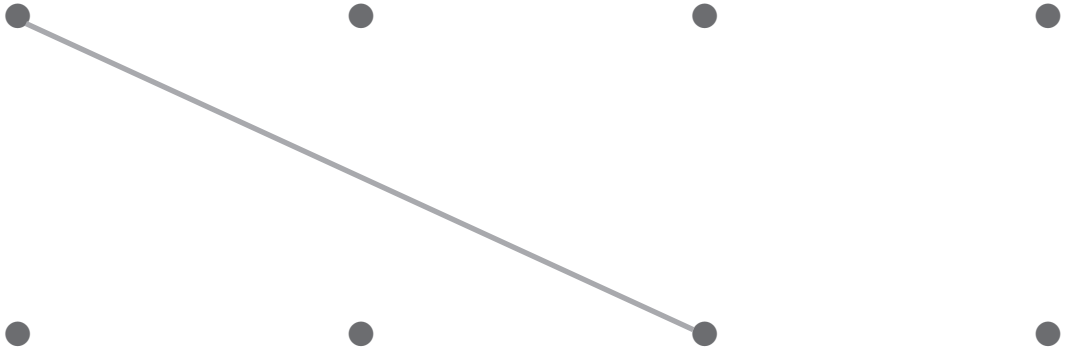
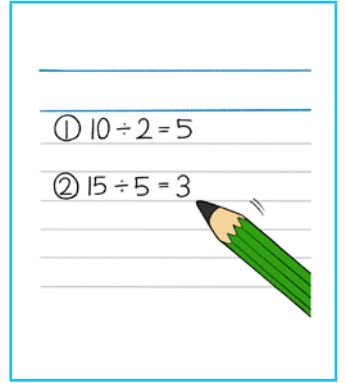
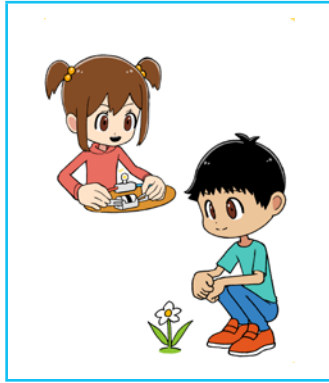

さんすう

しゃかい

こくご

りか

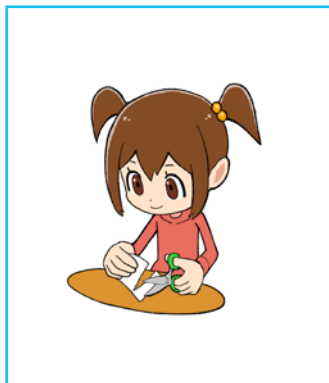

おんがく

どうとく

ずこう

たいいく



かきましよう



かけたら、こえにだして よみましよう

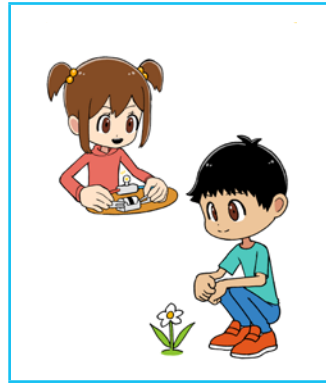
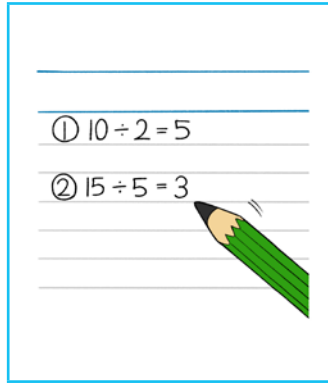

こくご

さんすう

りか

しゃかい

こくご

さんすう

りか

しゃかい

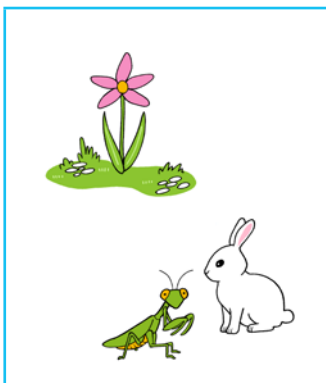
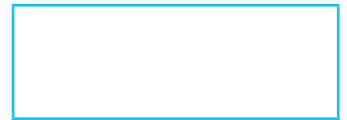
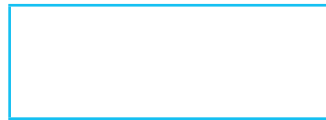
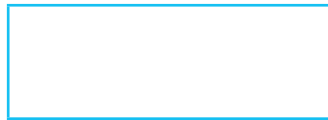
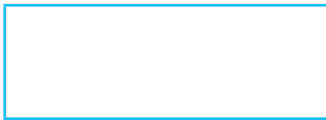

せいかつ

がいこくご

どうとく

せいかつ

がいこくご

どうとく

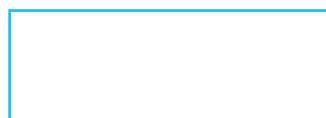
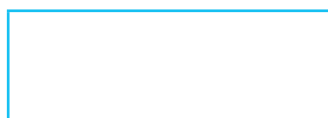
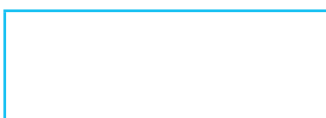

りかと しゃかいは
3ねんせいから
はじまるよ。





かきましよう



かけたら、こえにだして よみましよう



おんがく

ずこう

たいいく

おんがく

ずこう

たいいく

じぶんの クラスの じかんわりを かきましよう

じかんわり ねん くみ

	げつ	か	すい	もく	きん
1					
2					
3					
4					
5					
6					

Decorative elements: Cc, 1+1=, a ruler, a pencil, a clock, a water bottle, a globe, a basketball, a DNA helix, a flask, a test tube, a backpack, a heart, and various letters (A, B, C).



ことばを えらんで かきましょう

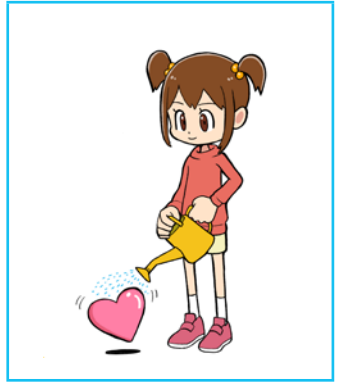
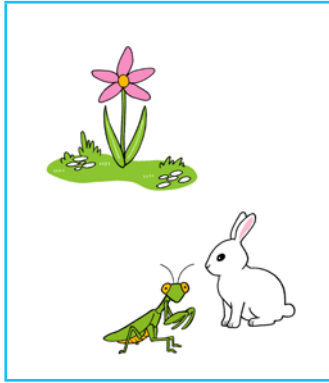

おんがく

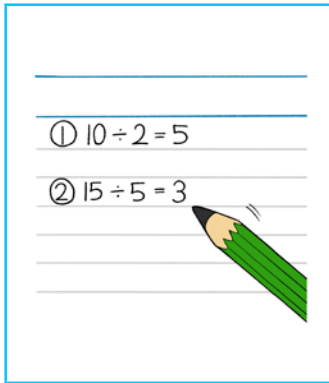
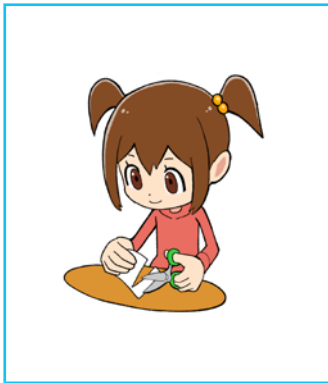

こくご

さんすう

せいかつ

がいこくご

どうとく

たいいく

おんがく

ずこう

せんで むすびましょう

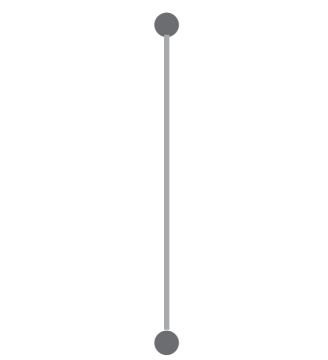
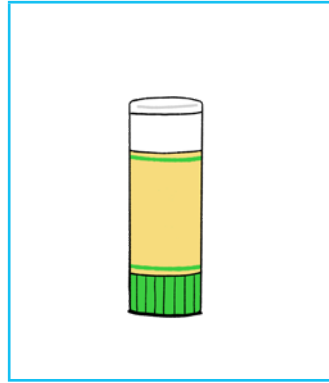
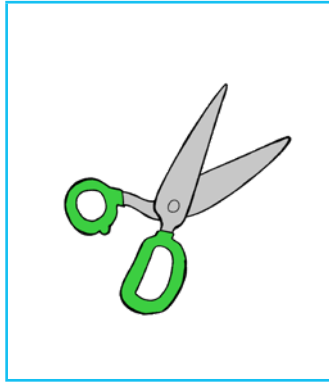

リコーダー

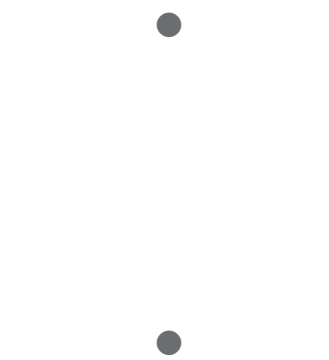

たいそうふく

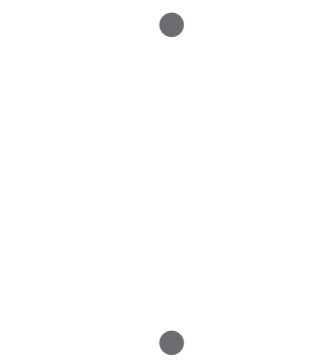

のり

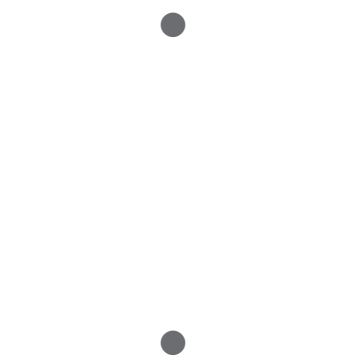

はさみ

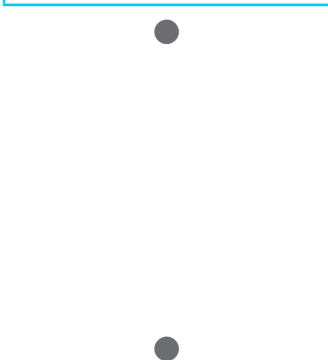
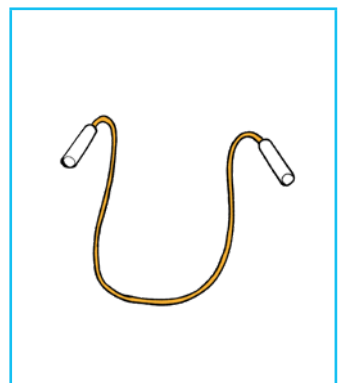
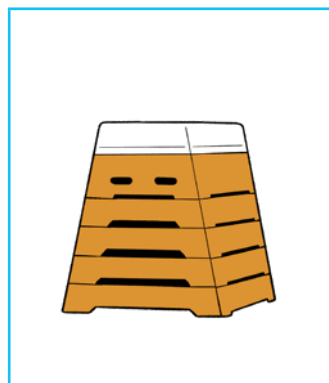
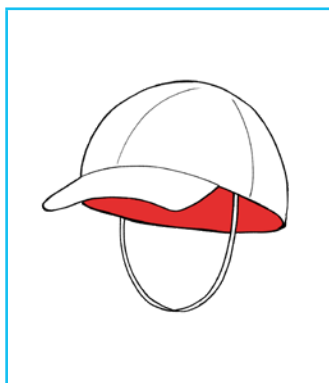
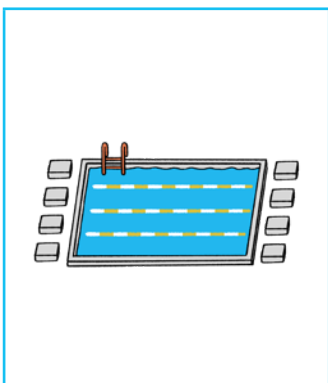

あかしろぼうし

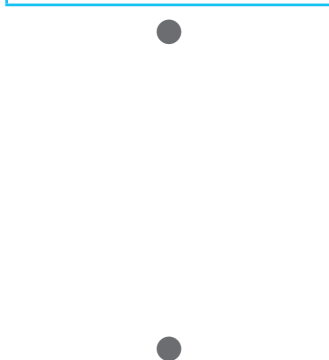

なわとび

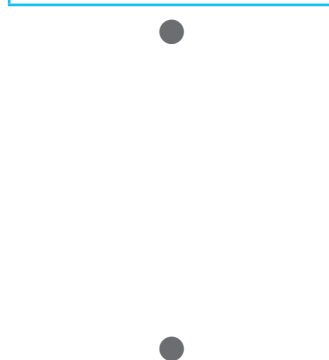

プール

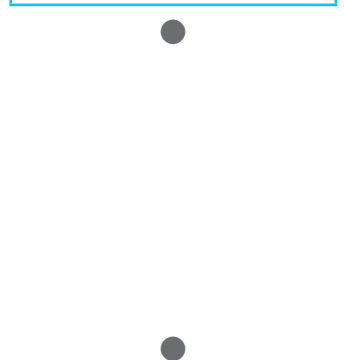

とびばこ



かきましよう



かけたら、こえにだして よみましよう

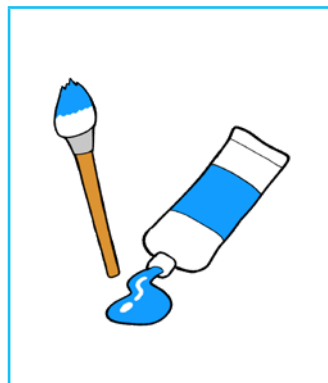
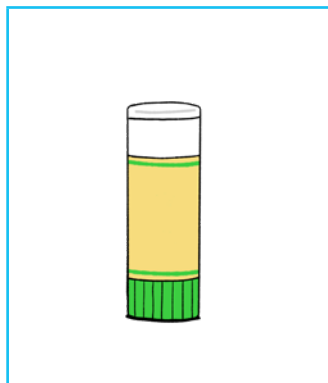
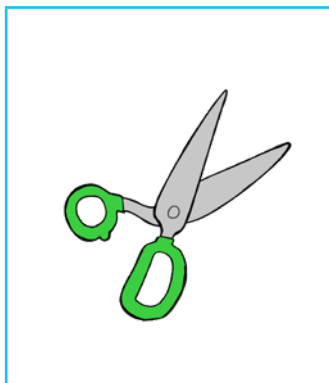
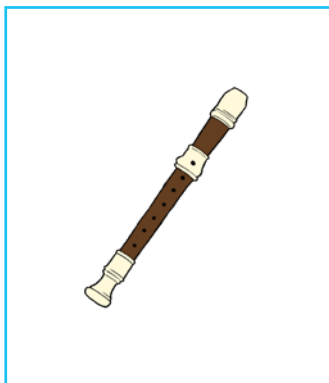

リコーダー

はさみ

のり

えのぐ

リコーダー

はさみ

のり

えのぐ

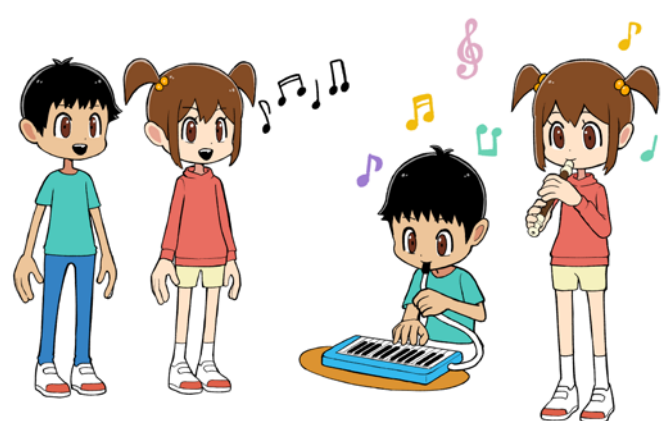
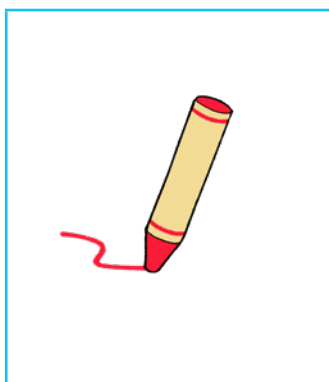
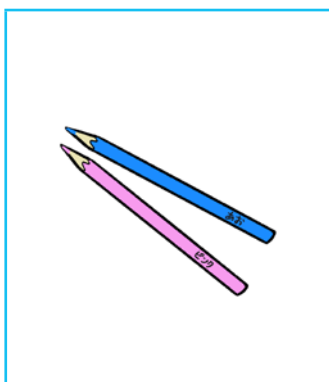
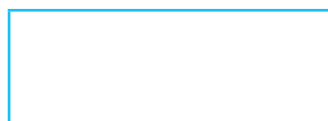
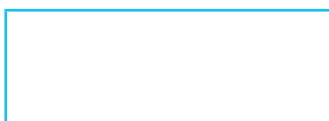

いろえんぴつ

クレヨン

いろえんぴつ

クレヨン

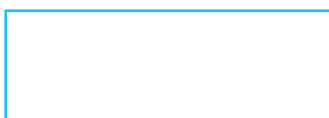



かきましよう



かけたら、こえにだして よみましよう

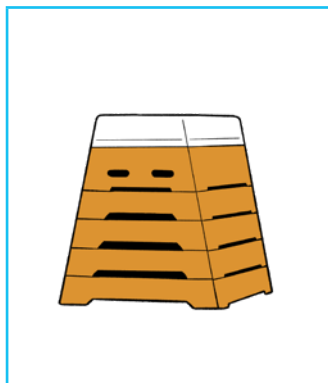
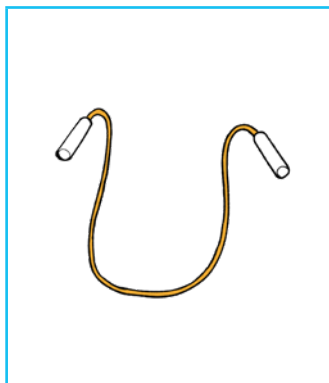
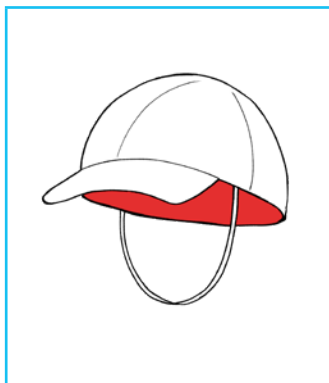

たいそうふく

あかしろぼうし

なわとび

とびばこ

たいそうふく

あかしろぼうし

なわとび

とびばこ

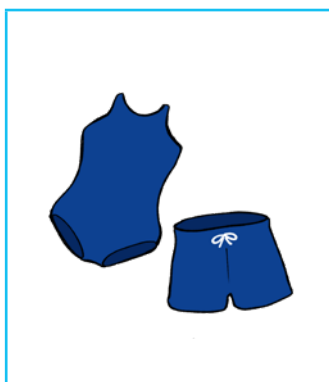
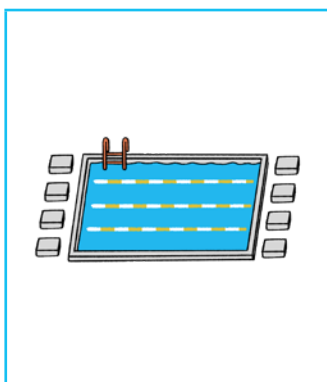

プール

みずぎ

プール

みずぎ





ことばを えらんで かきましょう

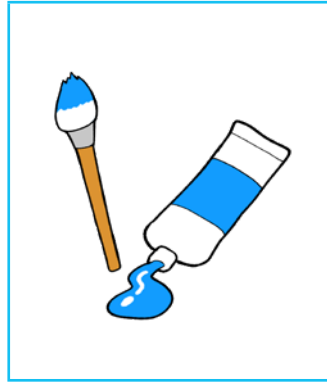
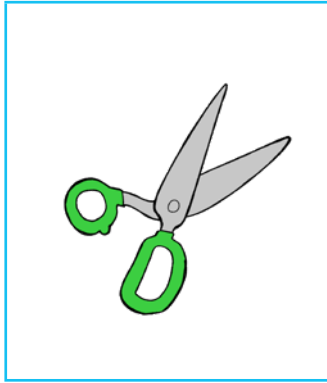
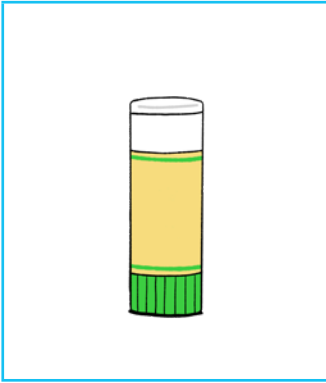

のり

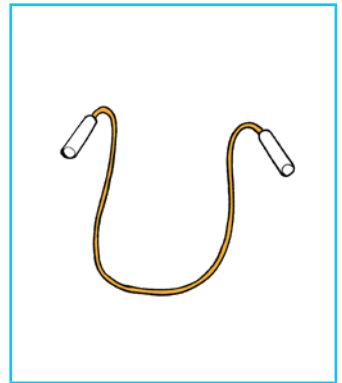
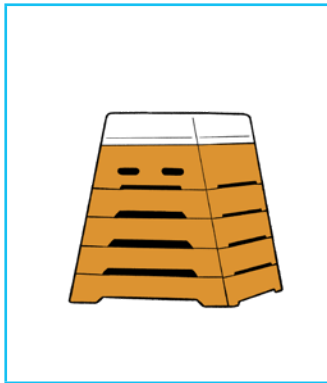
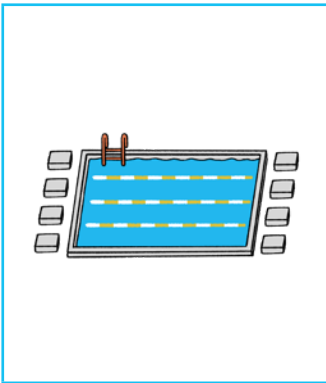

はさみ

のり

リコーダー

えのぐ

たいそうふく

なわとび

とびばこ

プール

先生が言ったことばがあらわすものを指さします。

さがしてみましよう



下のイラストがあらわすことばを探して、丸でかこみます。

のこった もじを
よこに
よんでみてね!

ことばさがし



に	ほ	く	つ	し	た	ん	ご	は	さ	み	の
こ	と	ば	を	あ	た	き	よ	う	か	し	よ
こ	く	ば	ん	か	く	さ	か	ん	お	ぼ	え
な	て	ね	と	し	★	お	さ	え	ん	ぴ	つ
わ	く	つ	び	ろ	た	い	そ	う	ふ	く	け
と	う	え	ば	ぼ	ん	の	り	し	て	る	し
び	よ	!	こ	う	が	な	ふ	だ	ん	ば	ご
ふ	で	ば	こ	し	う	わ	ば	き	れ	!	む

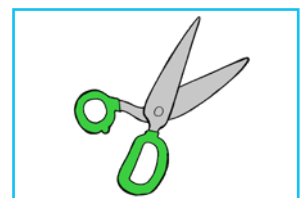
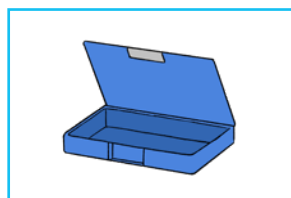
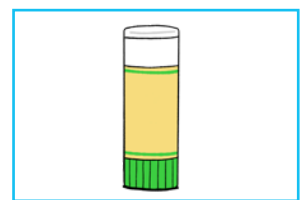
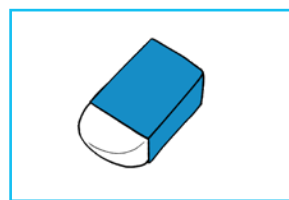
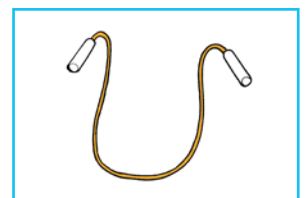
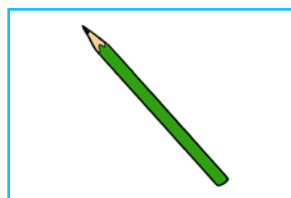
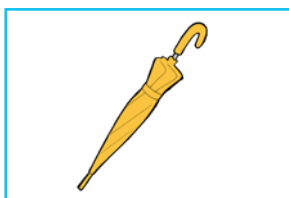

👤 できるようにしたいこと：体の部位を覚えて、自分の体の不調を伝えることができる 🧩

7 からだ

ことばの いみを せんせいと いっしょに かくにん しましょう

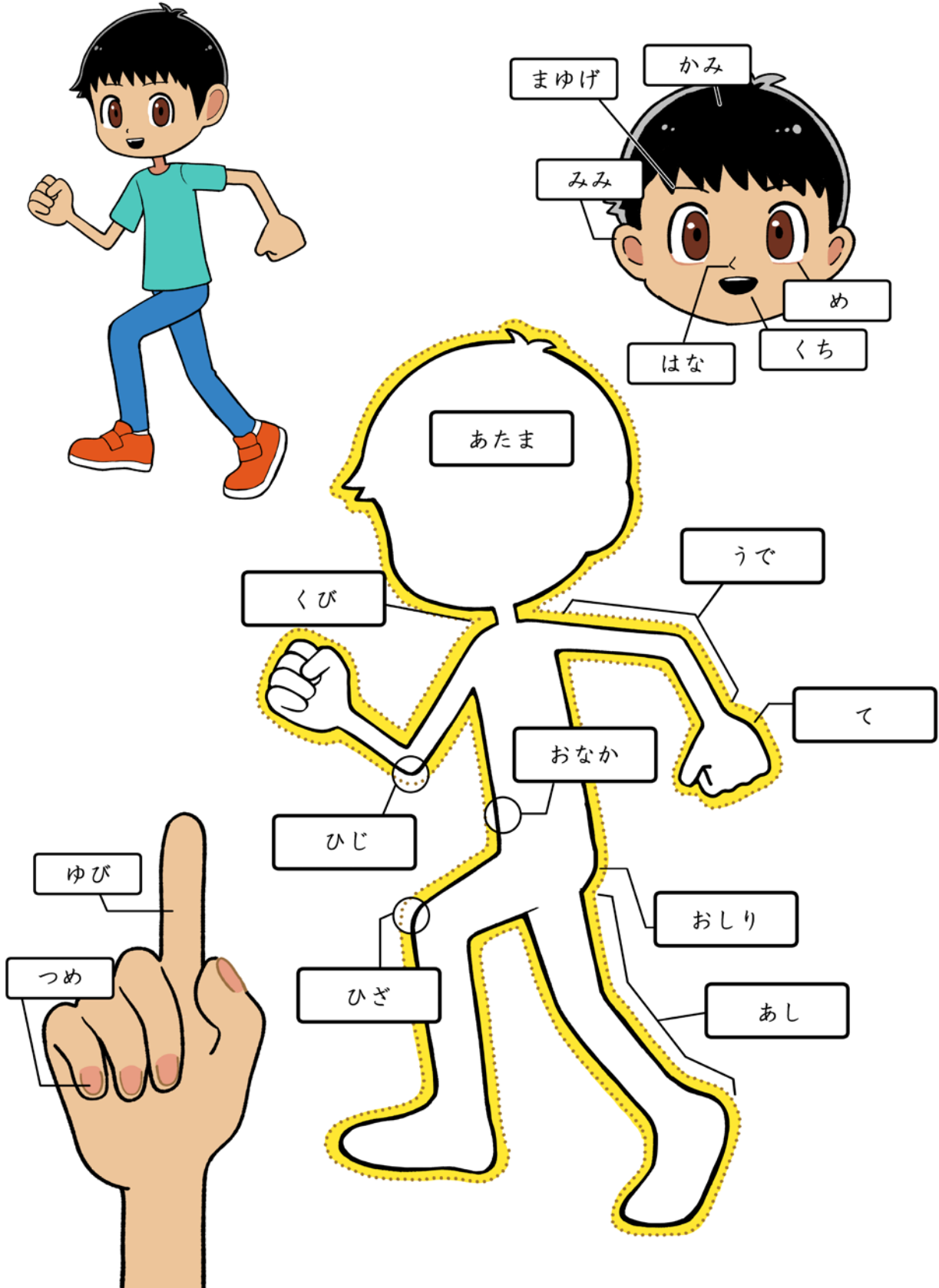

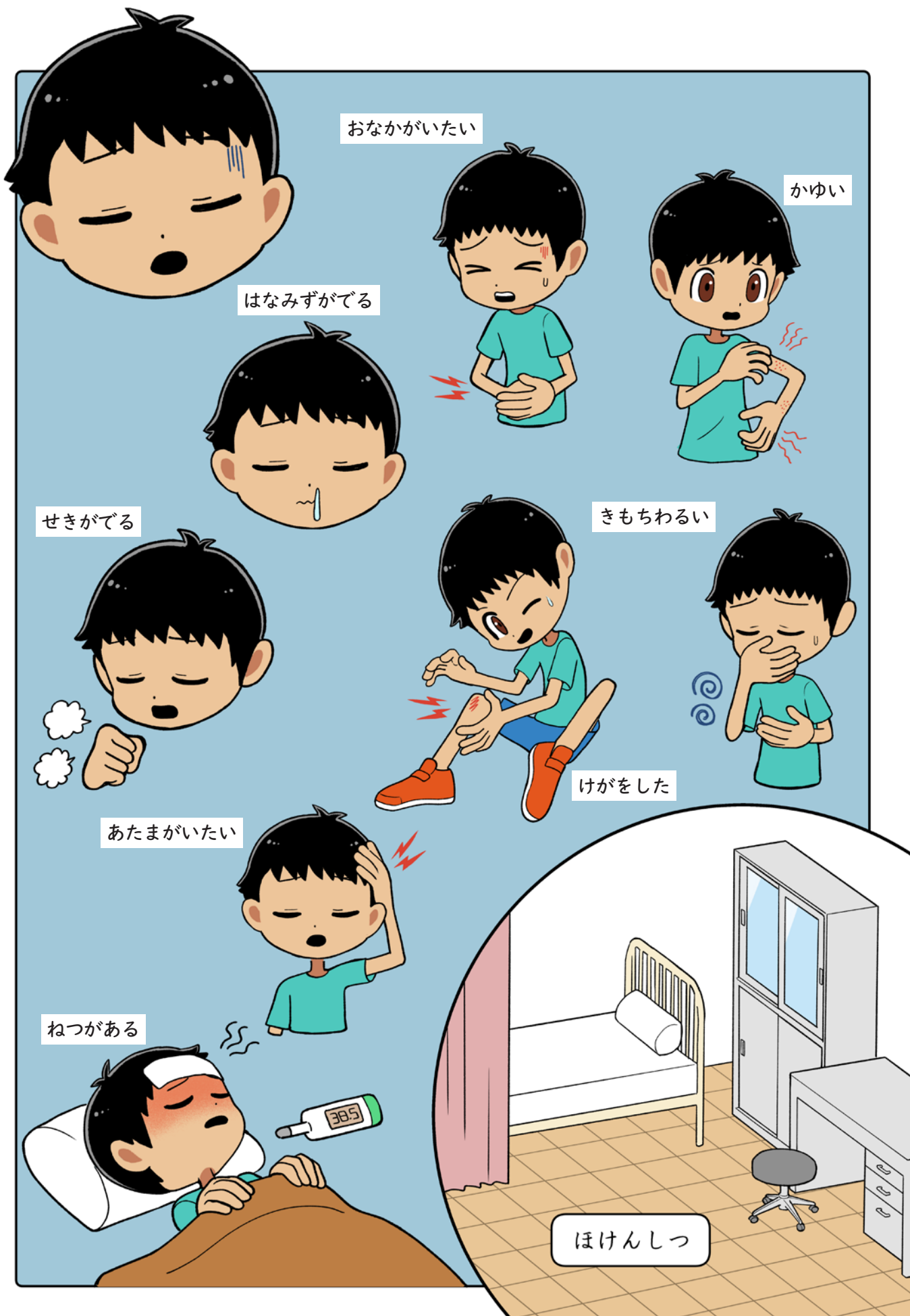

先生が言ったことばがあらわす部位を指さします。

ゆびで さしてみましよう



せんで むすびましょう



- おなか
- おしり
- て
- あし
- ひじ
- あたま
- くび
- うで
- ひざ



- め
- まゆげ
- みみ
- はな
- くち
- かみ
- つめ
- ゆび



①. せんで むすびましょう

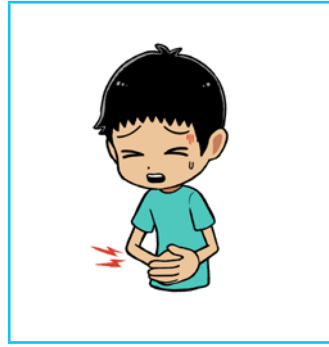
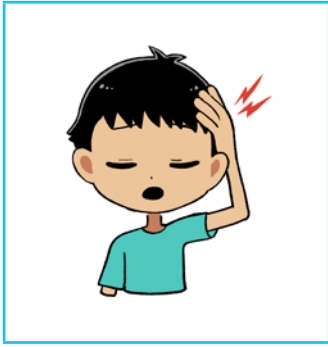

おなかがいたい

あたまがいたい

きもちわるい

けがをした



かきましょう



かけたら、こえにだして よみましょう

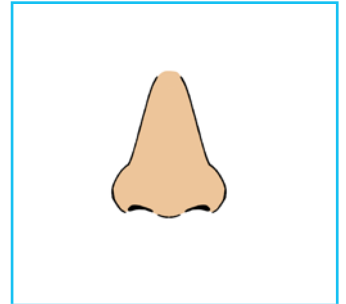
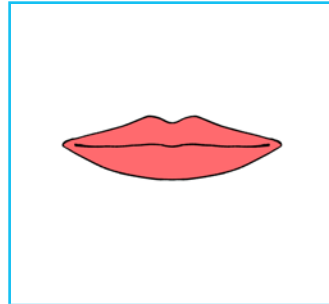
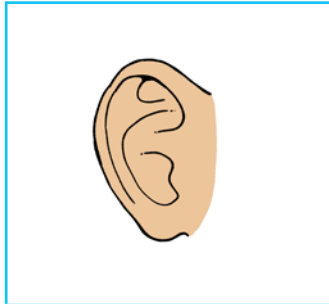
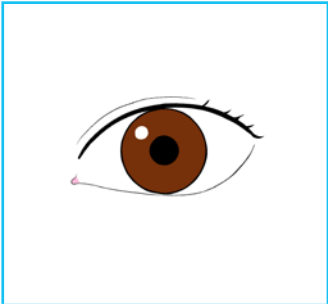

め

みみ

くち

はな

め

みみ

くち

はな

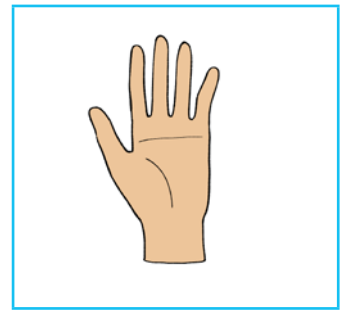
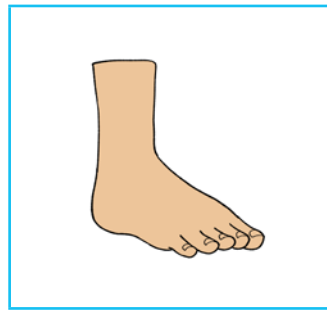
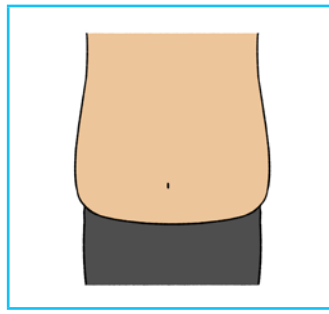
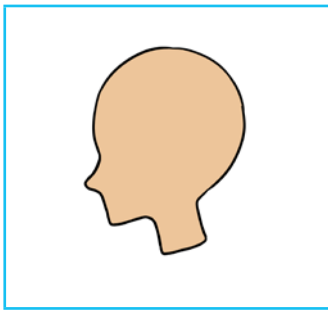

あたま

おなか

あし

て

あたま

おなか

あし

て

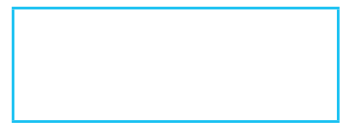
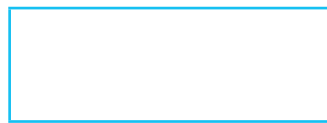
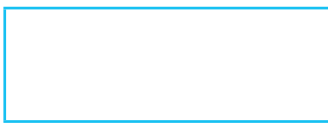

ことばを いれて いってみましょう



せんせい、() がいたいです。

せんせい、() わるいです。



せんせい、() がいたいです。

せんせい、() をしました。



げんきです。



ことばを えらんで かきましょう

かお

て

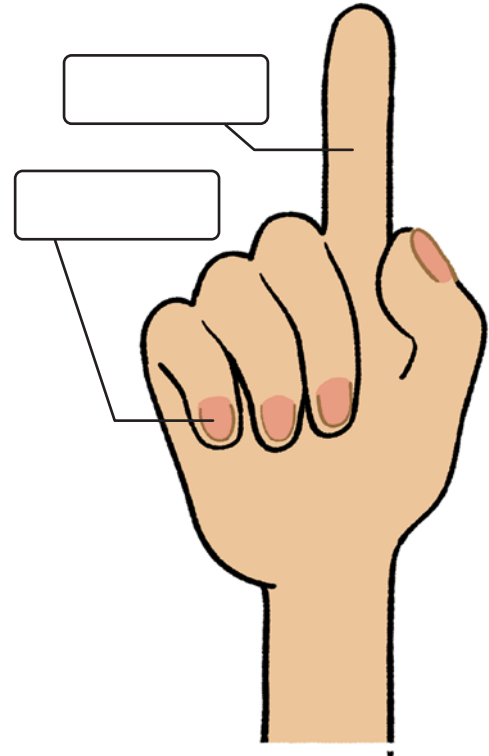
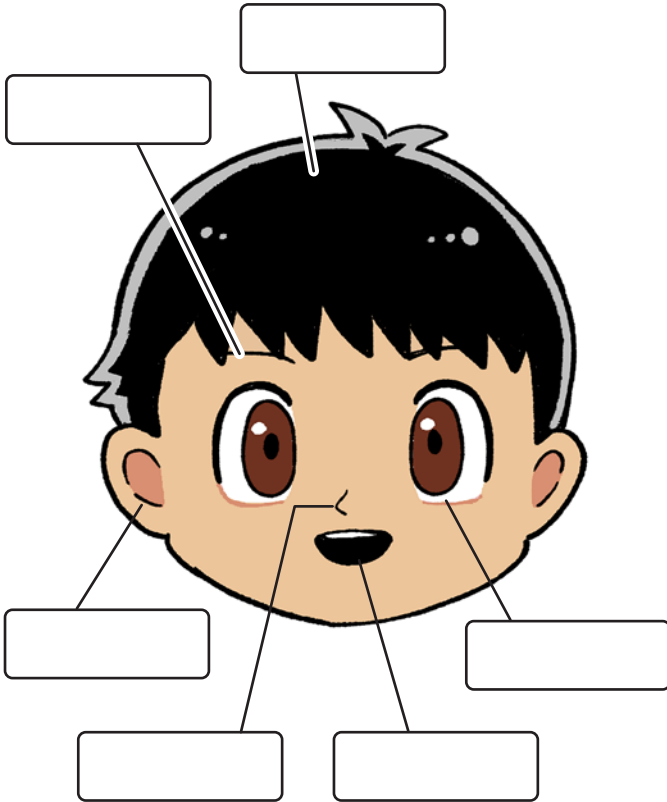

め

まゆげ

みみ

くち

はな

かみ

つめ

ゆび



ことばを えらんで かきましょう

からだ

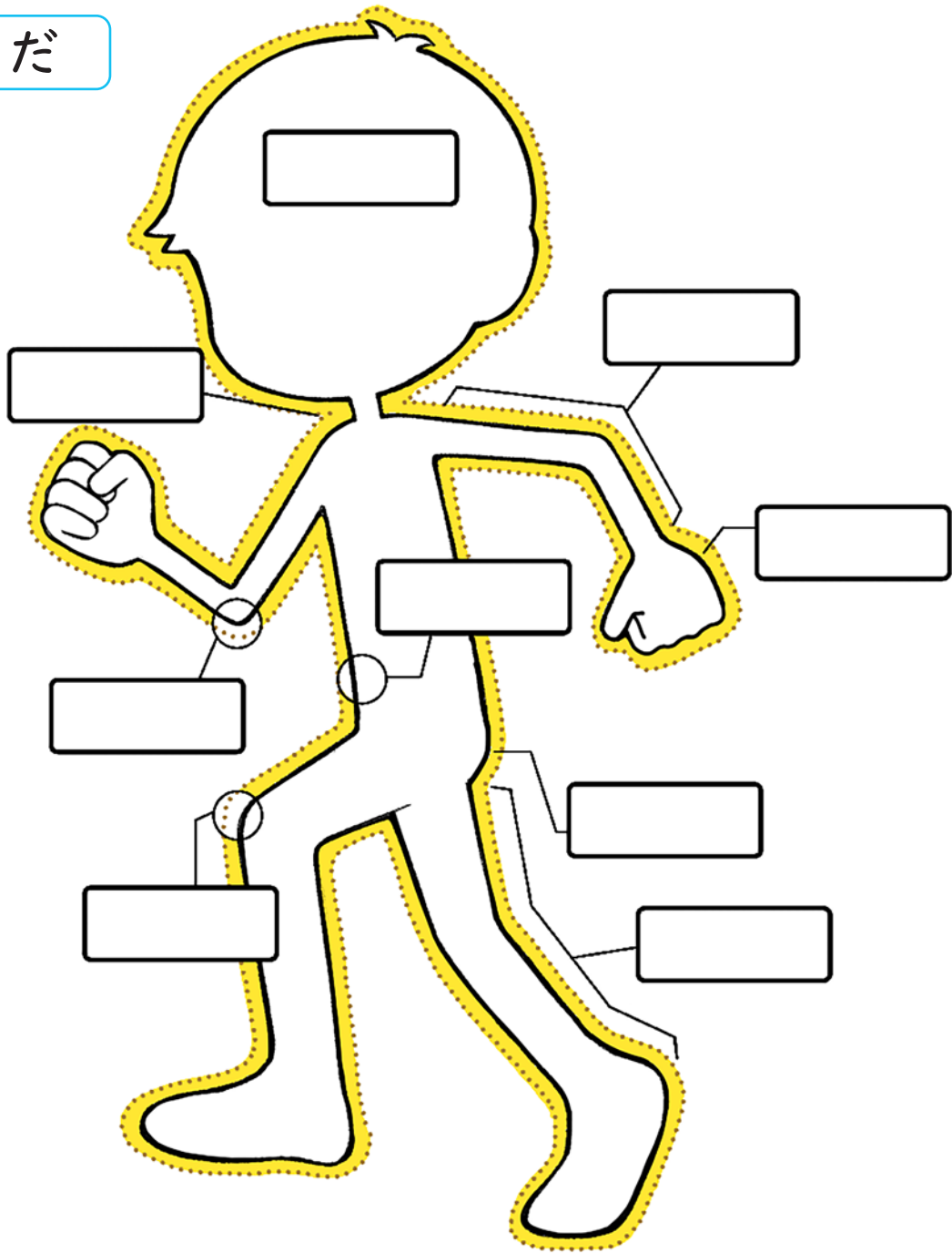

おしり

うで

ひじ

あたま

くび

あし

おなか

て

ひざ

👤 できるようにしたいこと：自分の気持ちや物の様子を言うことができる

8 きもち・ようす

うれしい



おもしろい



すき



かなしい



つまらない



きらい



あぶない



おいしい



ねむい



こわい



さみしい



かわいい



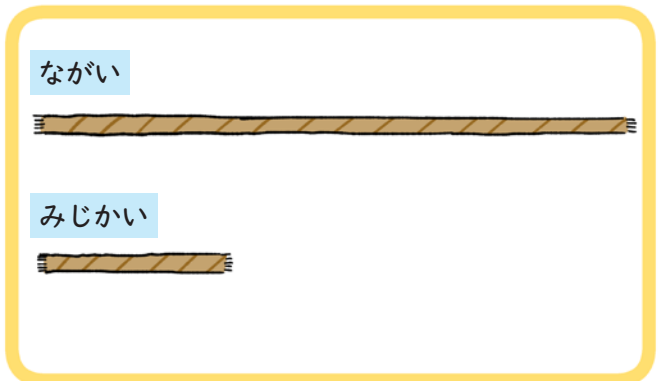
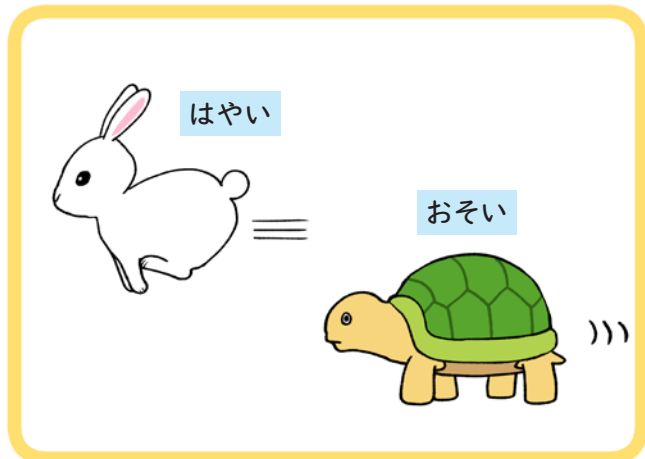
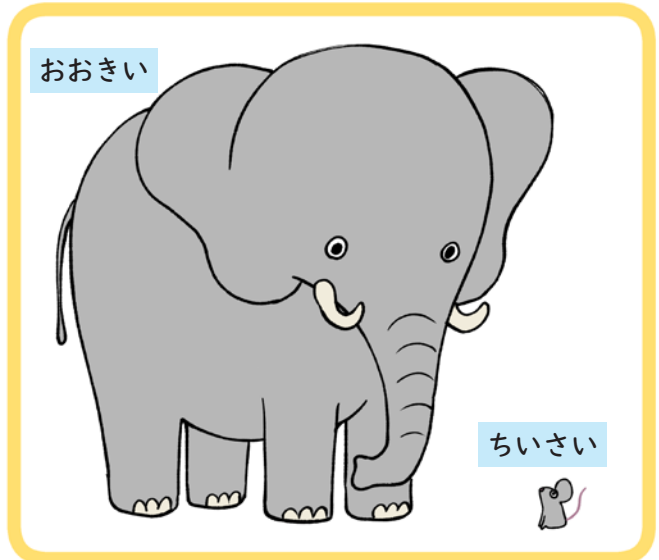
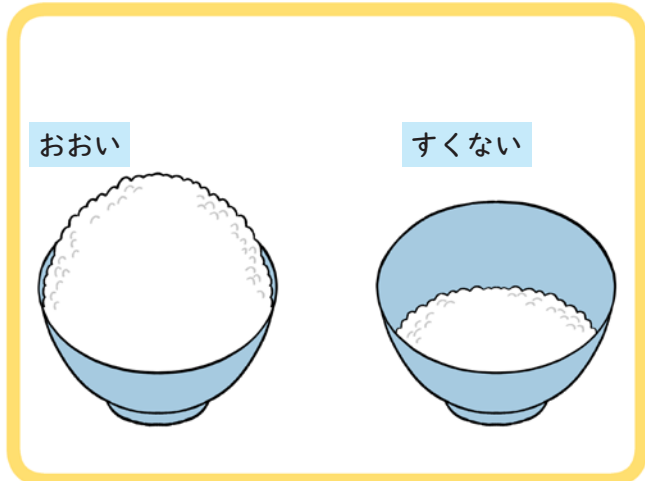
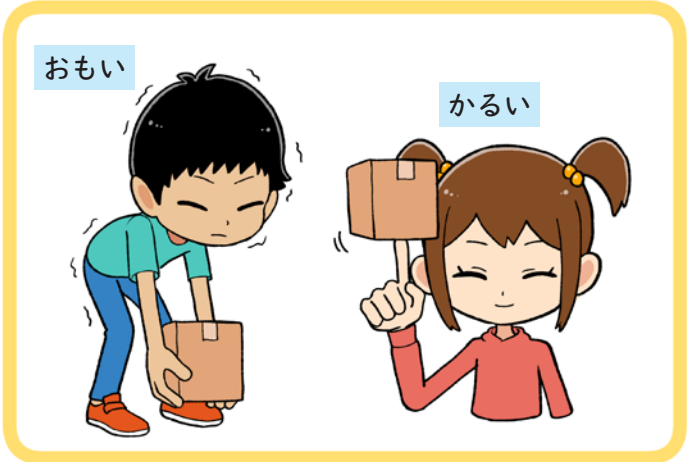
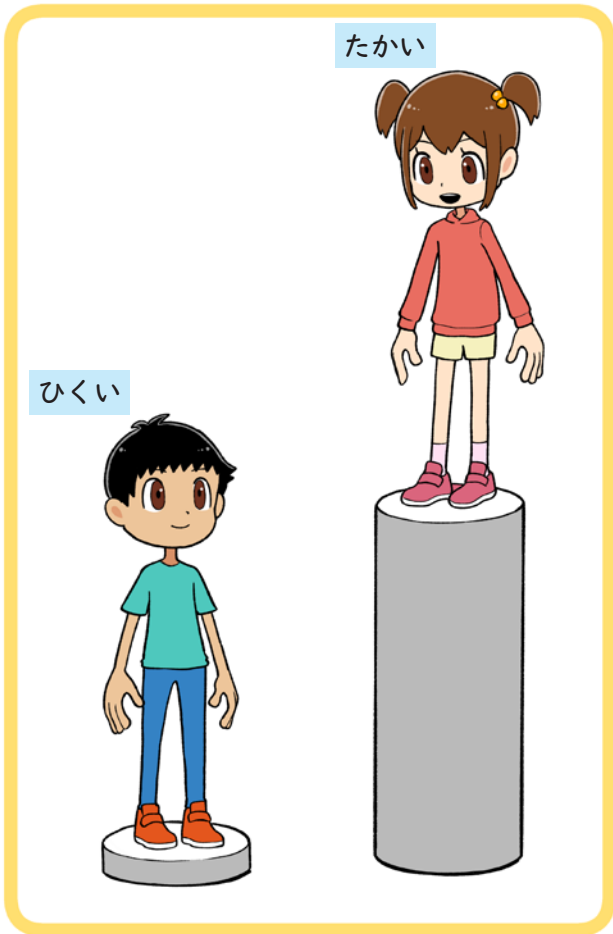

きたない

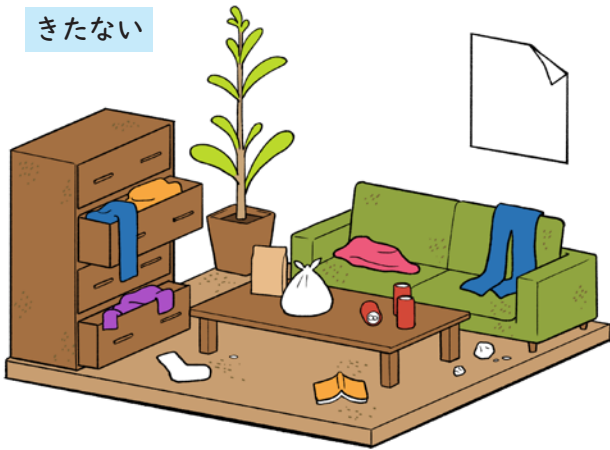

きれい

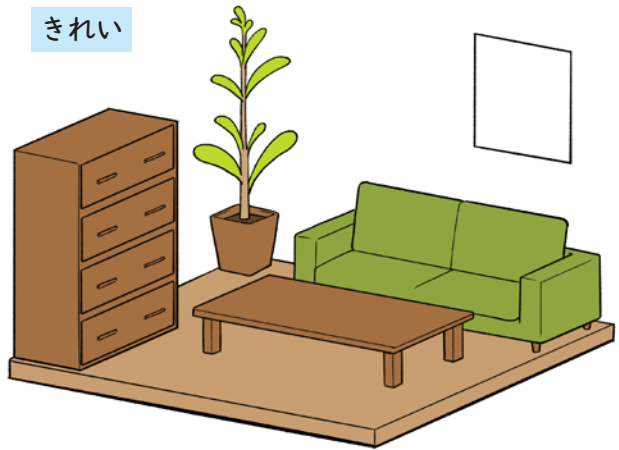

あたらしい



ふるい



やすい



たかい



せまい

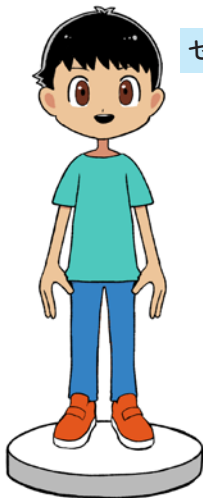

ひろい

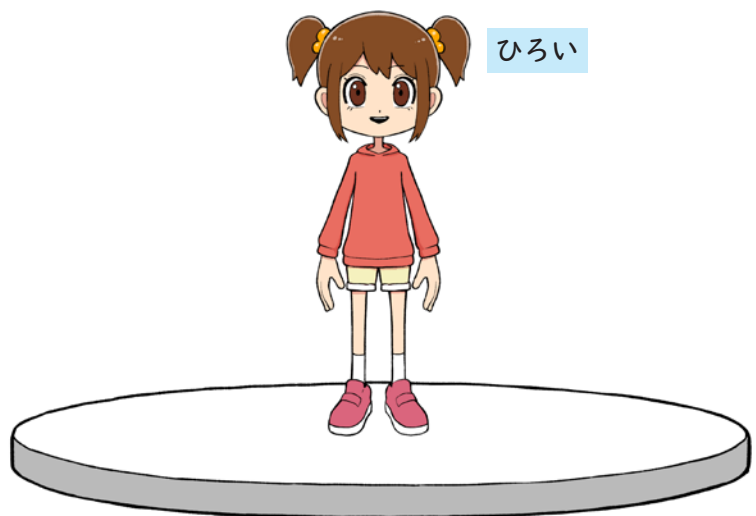

せんで むすびましょう

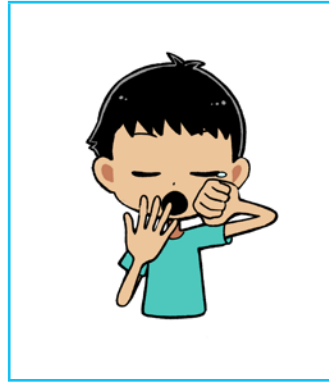
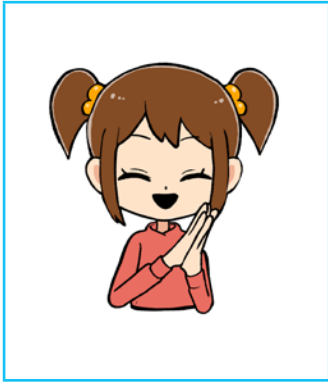

うれしい

ねむい

さみしい

おもしろい

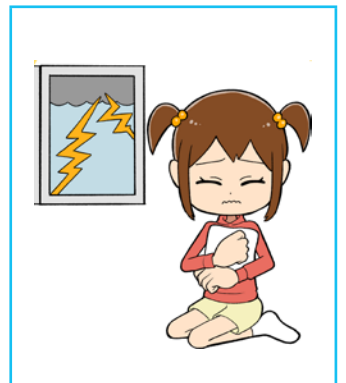
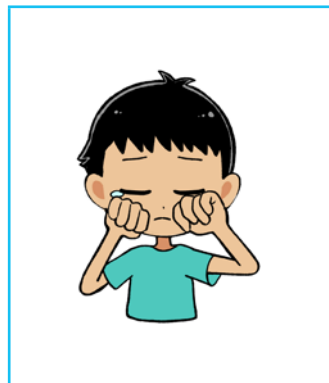
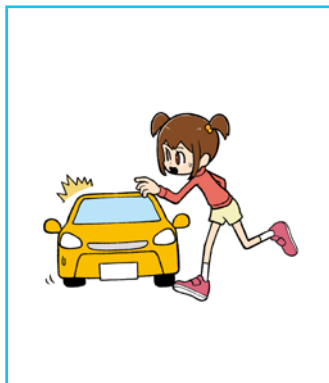

こわい

かなしい

あぶない

おいしい

せんて むすびましょう

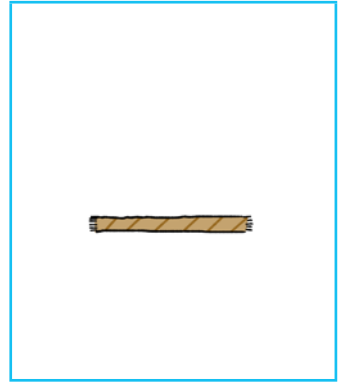
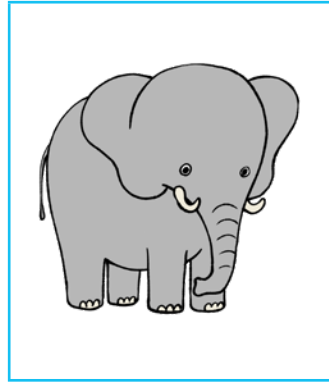
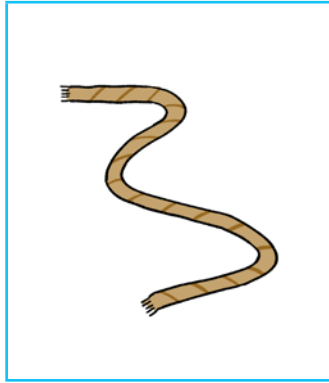

おおきい

ながい

ちいさい

みじかい

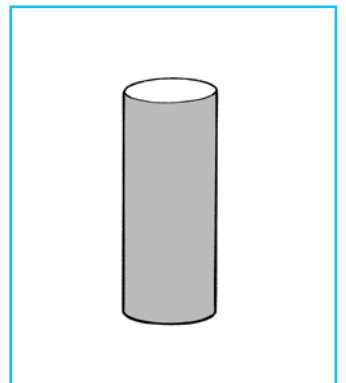
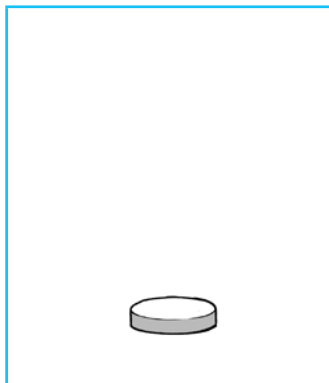

おもい

かるい

ひくい

たかい



かきましよう



かけたら、こえにだして よみましよう

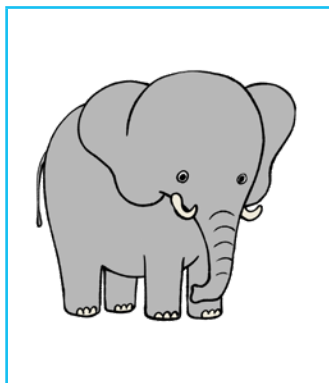
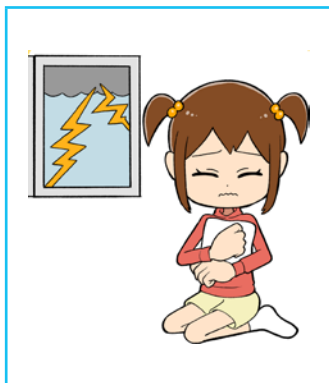

おいしい

こわい

おおきい

ちいさい

おいしい

こわい

おおきい

ちいさい

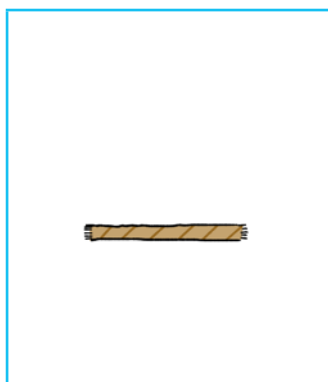
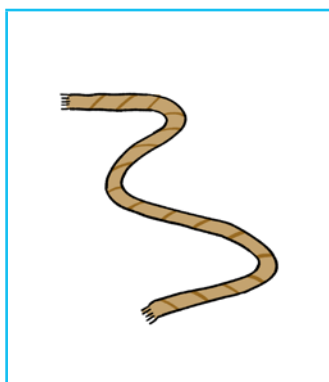
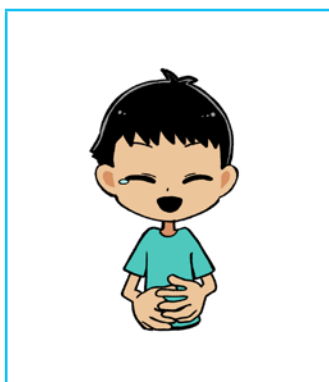

ねむい

おもしろい

ながい

みじかい

ねむい

おもしろい

ながい

みじかい



かきましよう



かけたら、こえにだして よみましよう

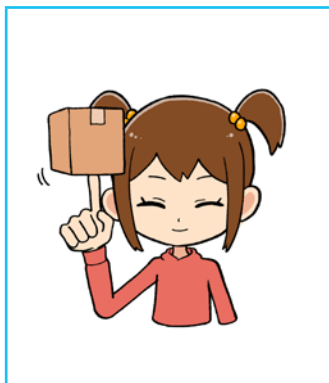

おもい

かるい

かなしい

あぶない

おもい

かるい

かなしい

あぶない

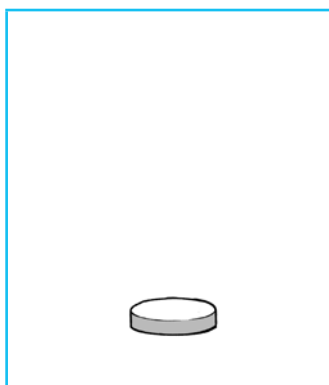
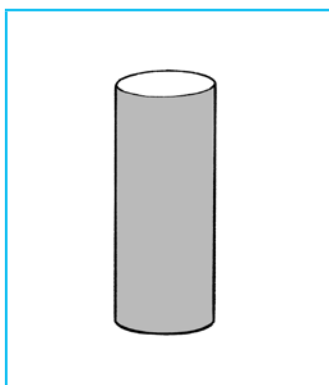

うれしい

たかい

ひくい

さみしい

うれしい

たかい

ひくい

さみしい



えが あらわす ことばを かきましょう



はんたいの ことばを せんで むすびましょう

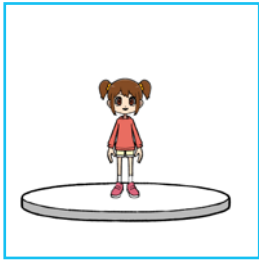

ひろい

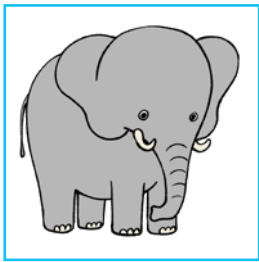
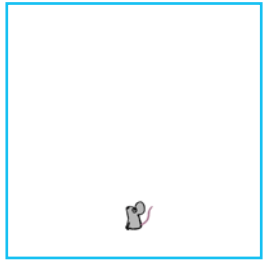

せまい

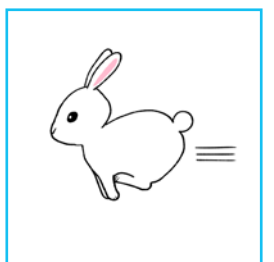
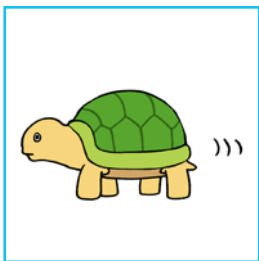



えが あらわす ことばを かきましょう



はんたいの ことばを せんで むすびましょう

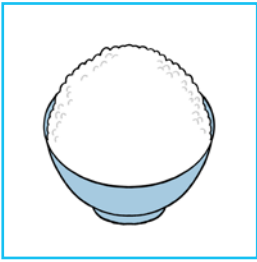

おいしい

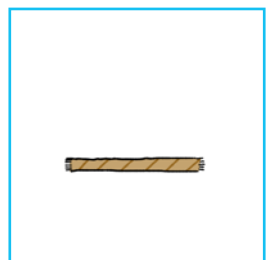
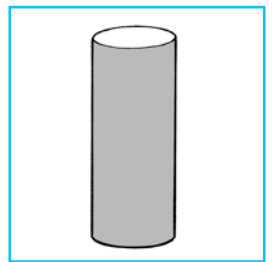
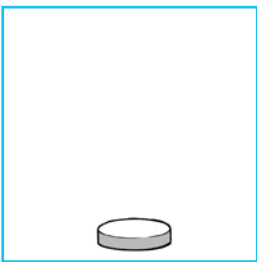
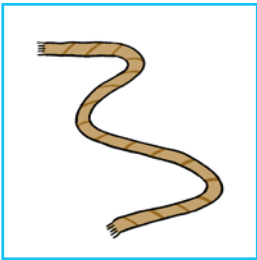

すくない

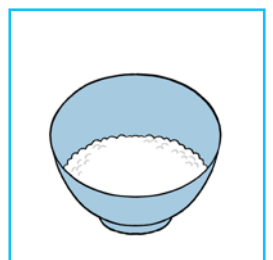

すきな きょうかを ○で かこみましょう
「わたし／ぼくは () がすきです。」といきましょう

こくご



さんすう

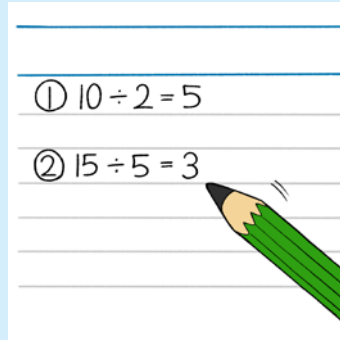

りか



しゃかい



がいこくご



ずこう



たいいく

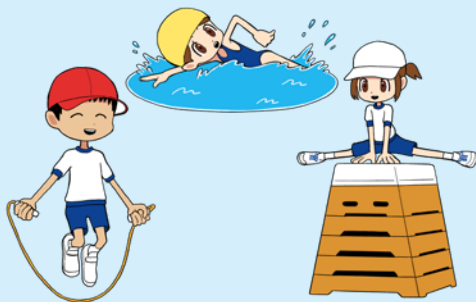

おんがく



えらびましょう

- ・「ながい」ものは どれですか。 ()
- ・「おおきい」ものは どれですか。 ()
- ・「たかい」ものは どれですか。 ()

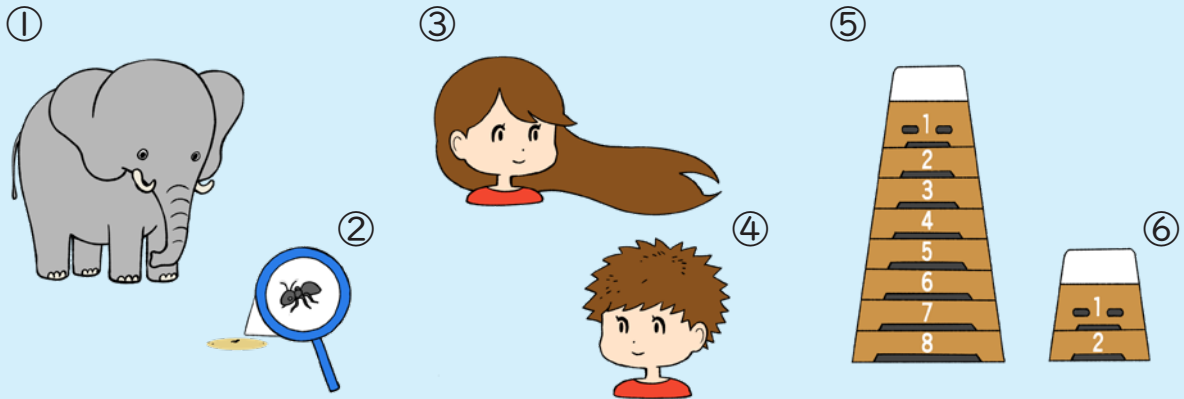

- ・「ひくい」ものは どれですか。 ()
- ・「ちいさい」ものは どれですか。 ()
- ・「みじかい」ものは どれですか。 ()

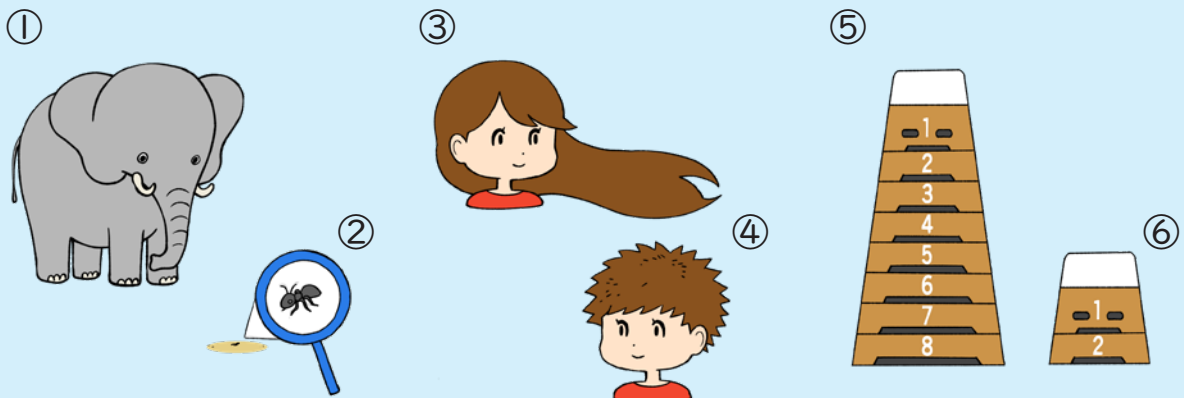

えの なかで 「ながい」 「おおきい」 「たかい」
「みじかい」 「ちいさい」 「ひくい」 を さがしましょう

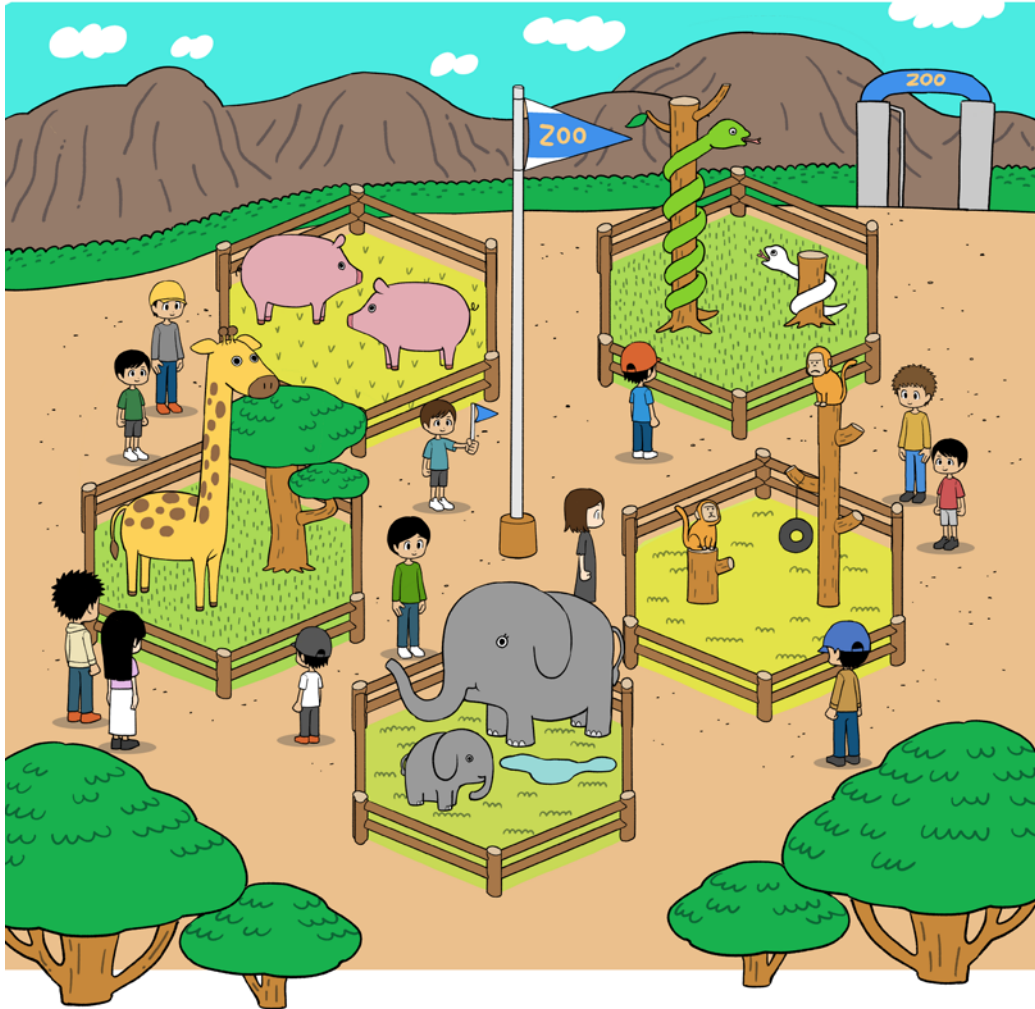

がっこうの なかを せんせいと あるいて
べんきょうした ことばを さがしましょう

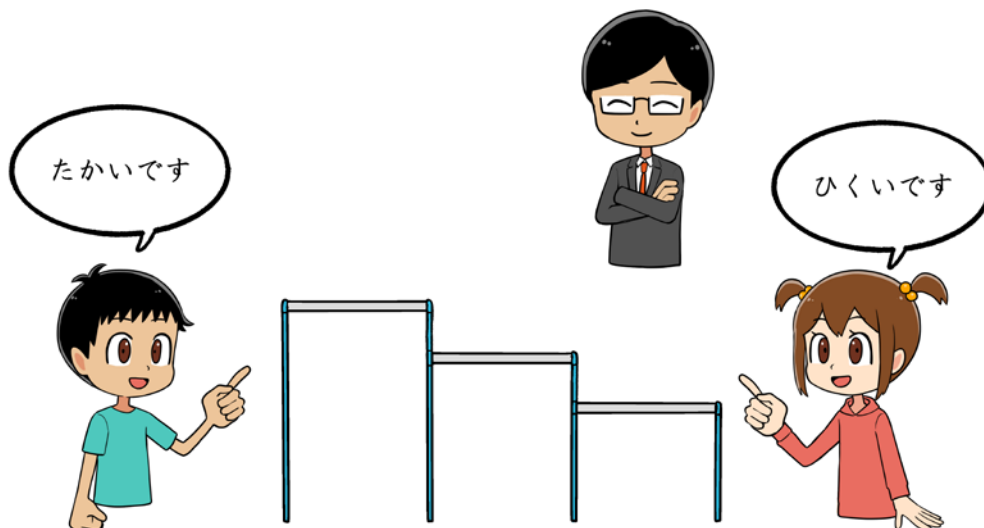

👤 できるようにしたいこと：自分の家族を紹介できる

9 かぞく

ことばの いみを せんせいと いっしょに かくにん しましょう

かぞく / きょうだい

わたしの かぞく

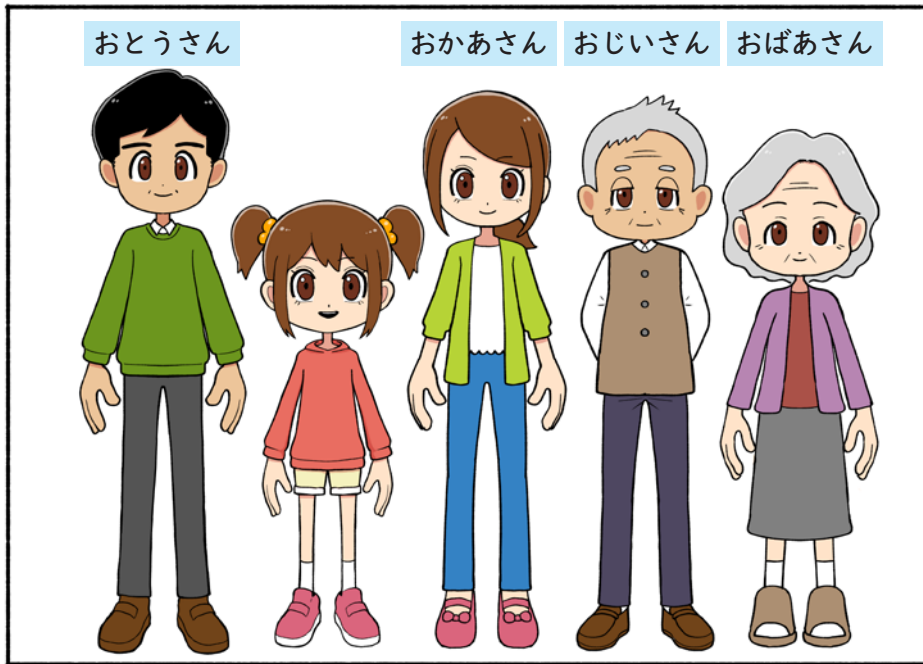

ぼくの きょうだい

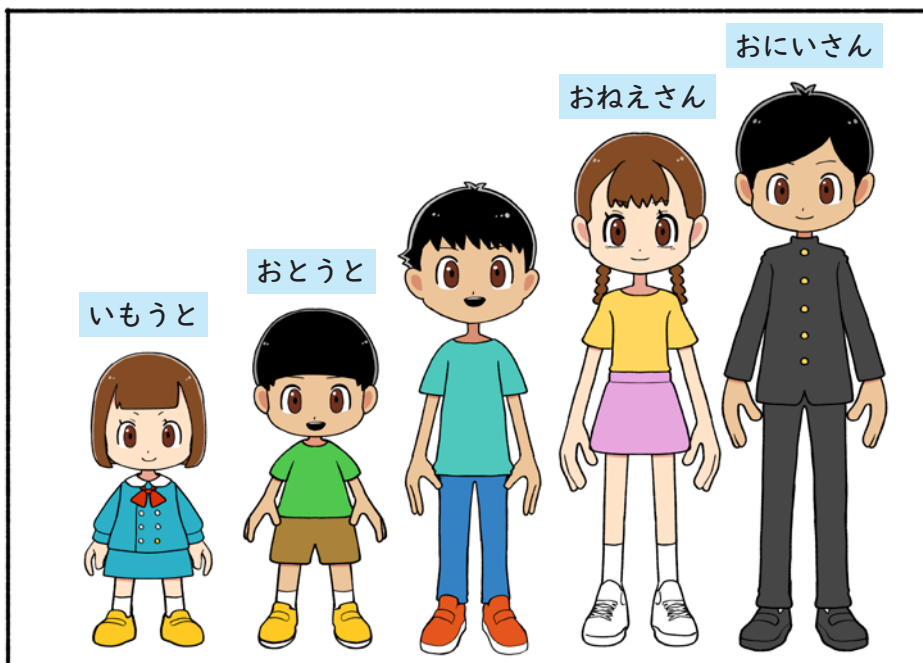



かきましよう



かけたら、こえにだして よみましよう



おとうさん

おかあさん

おじいさん

おばあさん

おとうさん

おかあさん

おじいさん

おばあさん



おにいさん

おねえさん

おとうと

いもうと

おにいさん

おねえさん

おとうと

いもうと



ことばを えらんで かきましょう

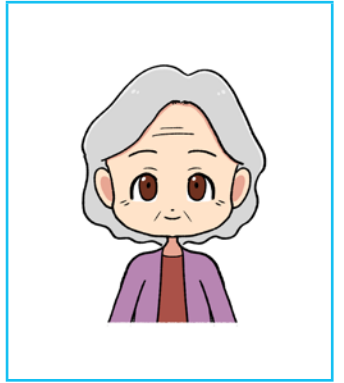
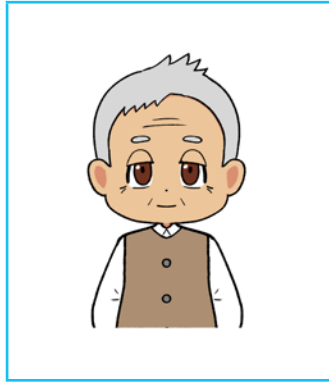
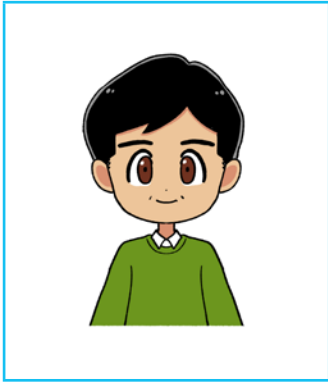

おとうさん

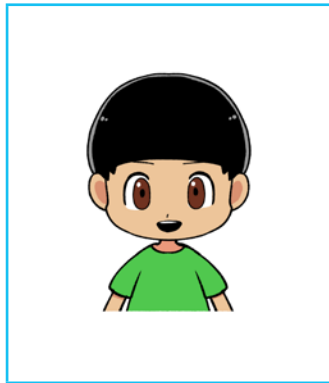
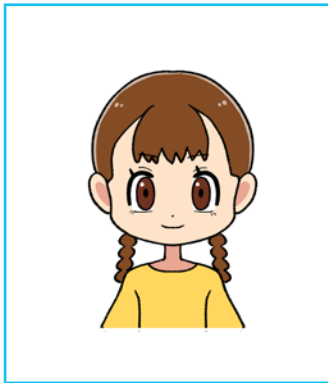

おじいさん

おとうと

おかあさん

おにいさん

いもうと

おねえさん

おばあさん

おとうさん

じぶんの かぞくを しょうかいしましょう



- ・わたしの かぞくは 5にんです。
- ・おとうさんと おかあさんと おじいさんと おばあさんが います。
- ・おとうさんは にほんごが はなせます。
- ・おかあさんは やさしいです。



- ・ぼくの きょうだいは 5にんです。
- ・おにいさんと おねえさんと おとうとと いもうとが います。
- ・おねえさんは 5ねんせいです。
- ・おとうとは ほいくえんに いています。

・わたしの かぞくは _____ にんです。

・

・

・

・

・

できるよにしたいこと：通学路にあるもののがわかる

10 つうがくろ

ことばの いみを せんせいといっしょにかくにんしましょう

➡：つうがくろ (がっこうへいくみち)

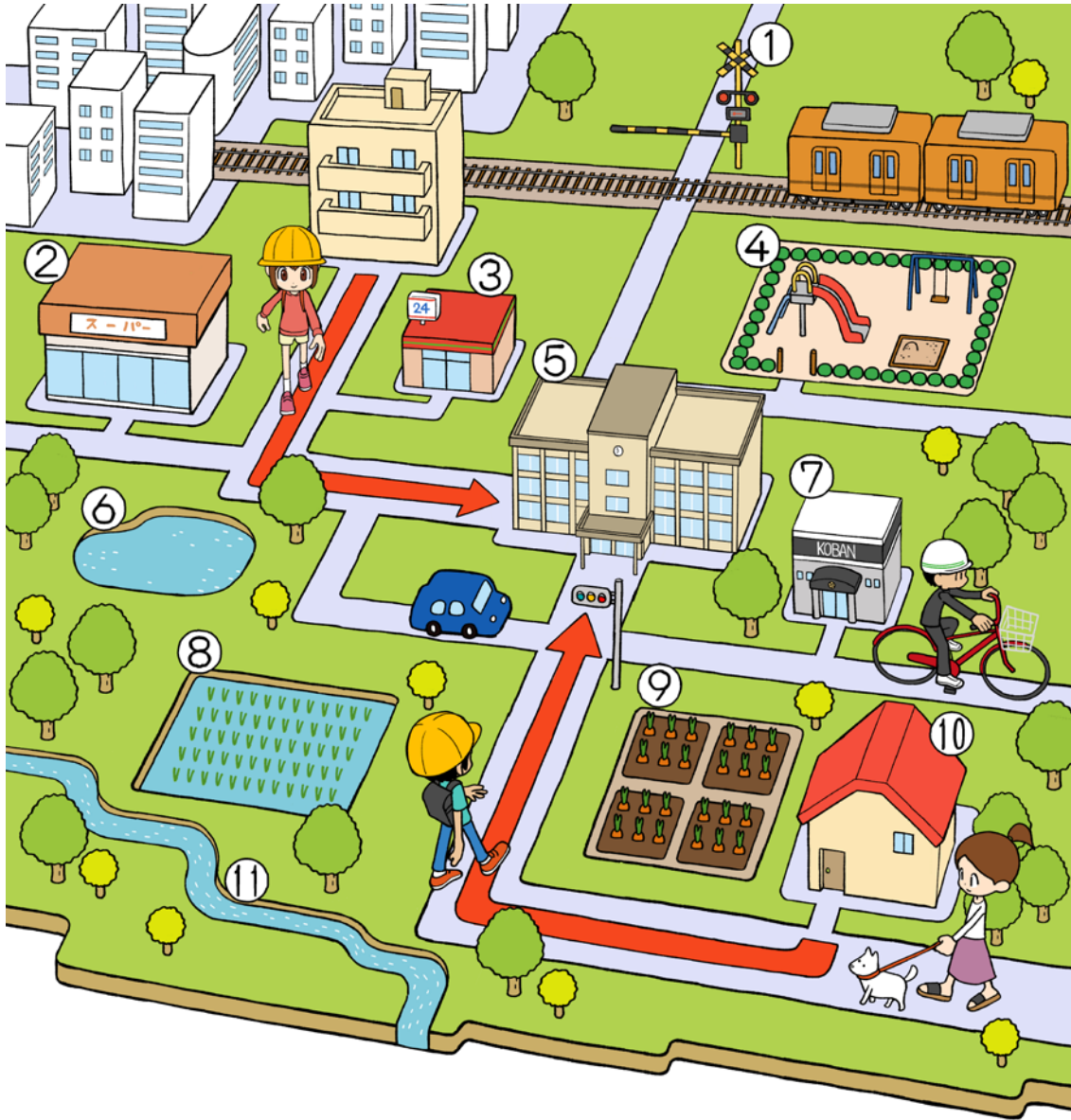

- ①ふみきり ②スーパー ③コンビニ ④こうえん
 ⑤がっこう ⑥いけ ⑦こうばん ⑧たんぼ
 ⑨はたけ ⑩いえ ⑪かわ

せんで むすびましょう

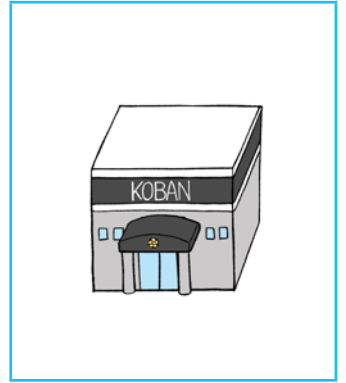
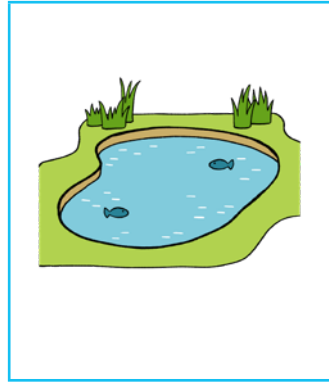
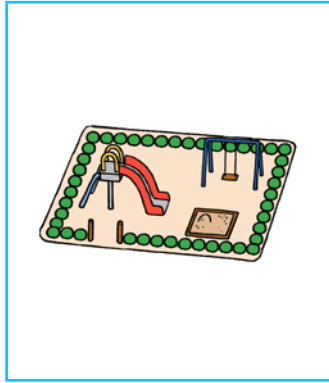
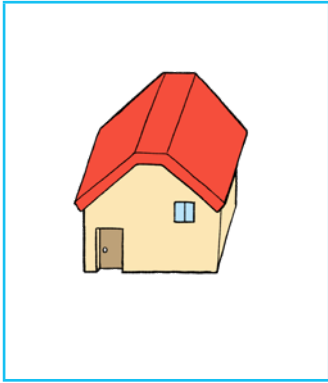

こうえん

いけ

こうばん

いえ

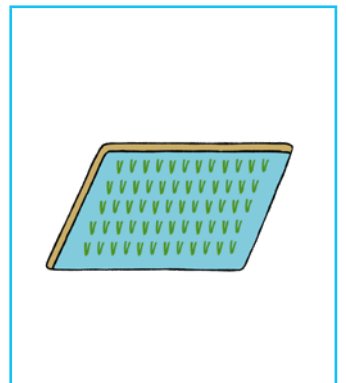
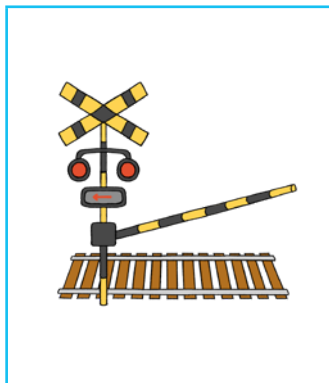
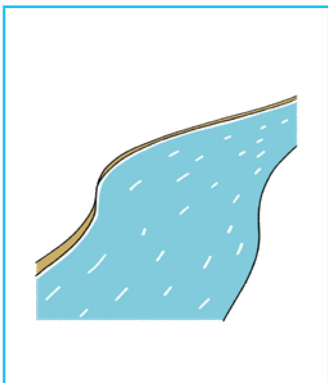

たんぼ

はたけ

かわ

ふみきり



かきましよう



かけたら、こえにだして よみましょう

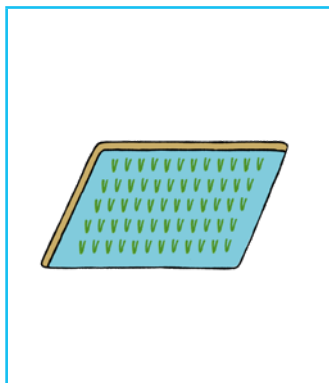
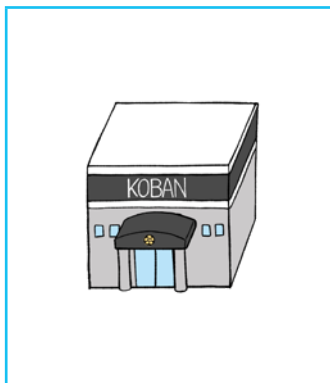
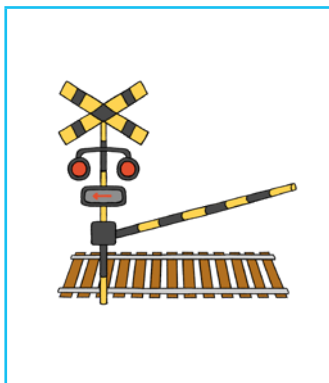

ふみきり

こうばん

たんぼ

はたけ

ふみきり

こうばん

たんぼ

はたけ

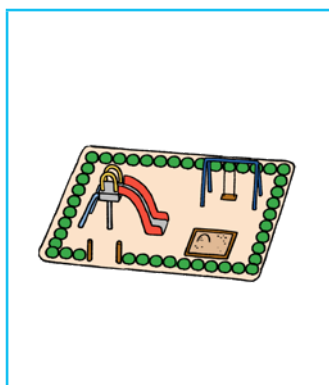
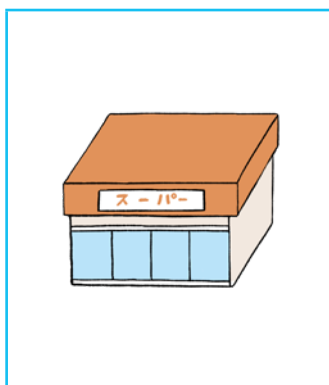
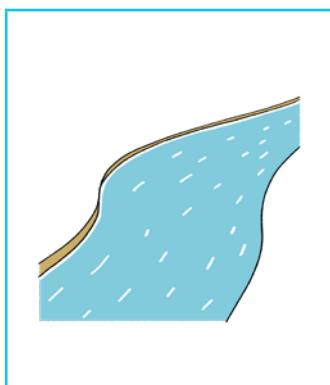
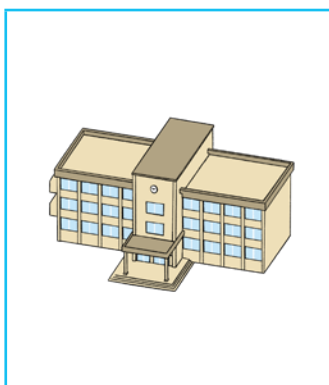
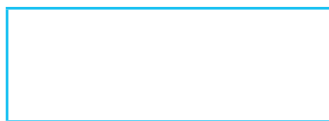
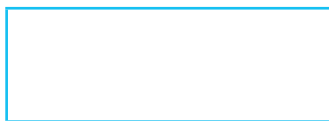
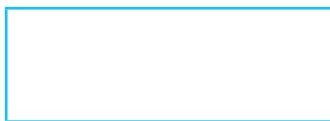
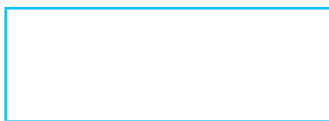

がっこう

かわ

スーパー

こうえん

がっこう

かわ

スーパー

こうえん

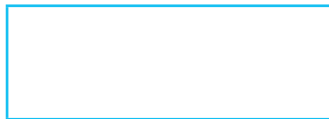
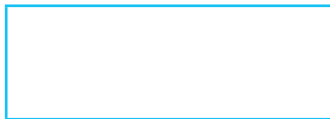
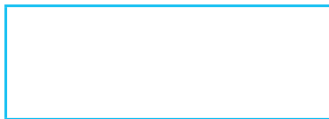



ことばを えらんで かきましょう

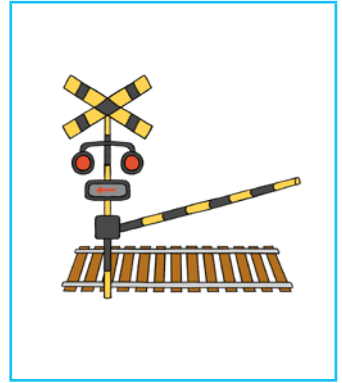
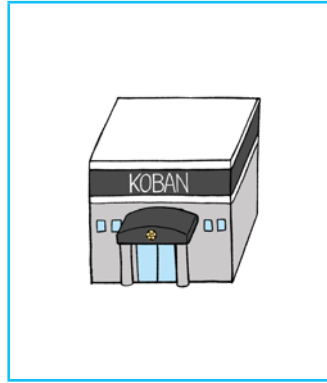
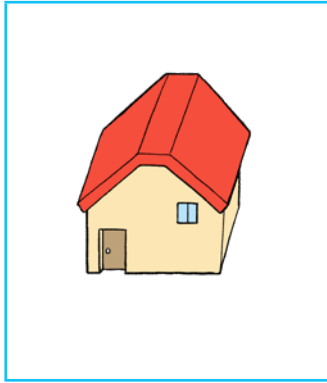
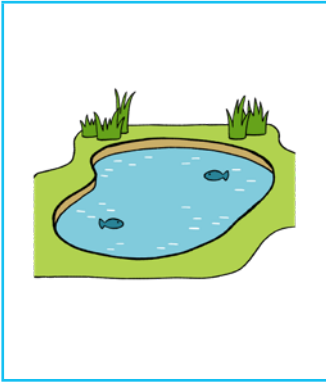

いけ

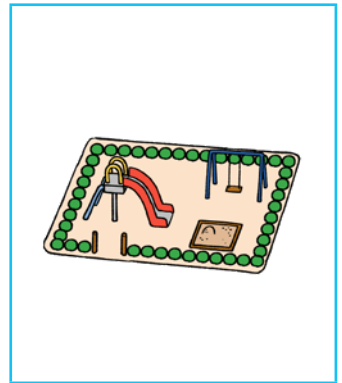
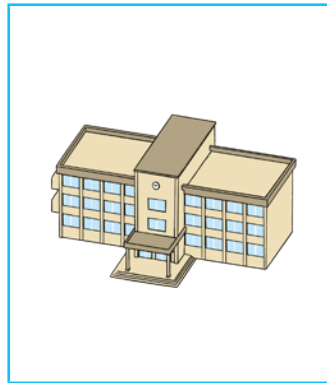
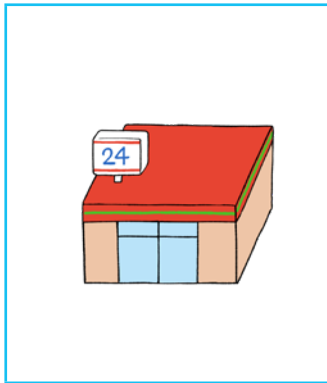
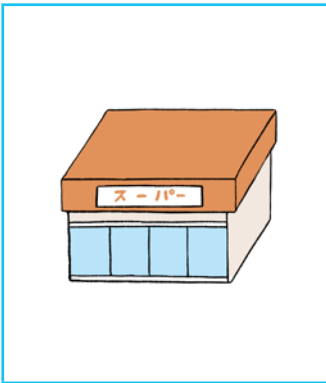

こうえん

ふみきり

スーパー

いけ

コンビニ

がっこう

いえ

こうばん

ことばの いみを せんせいといっしょにかくにんしましょう

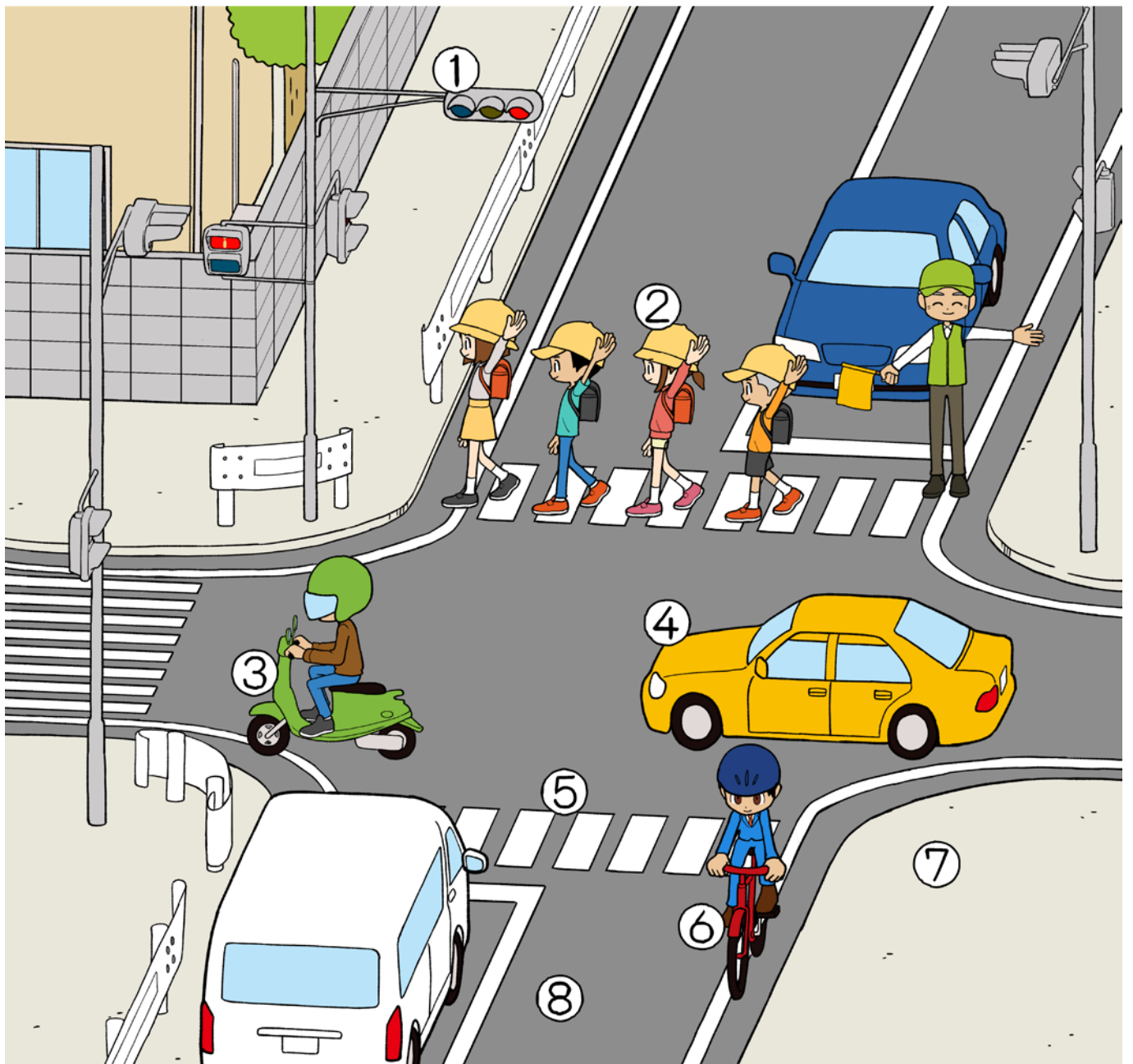

- ①しんごう ②つうがくはん ③バイク
④くるま ⑤おうだんほどう ⑥じてんしゃ
⑦ほどう ⑧どうろ

せんて むすびましよう

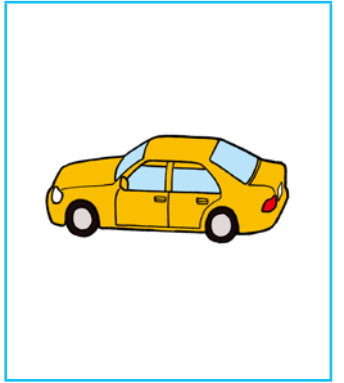
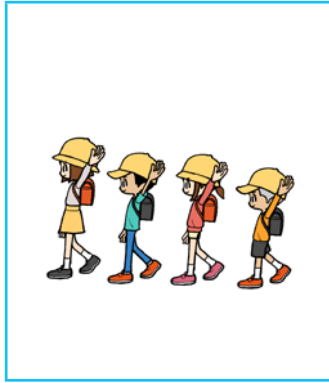
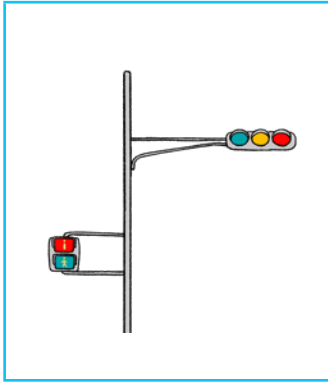
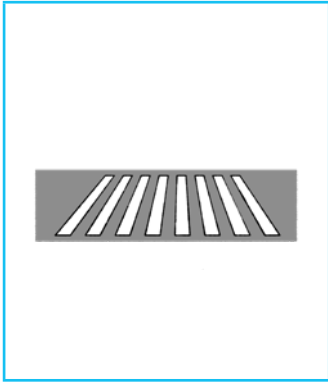

くるま

つうがくはん

おうだんほどう

しんごう

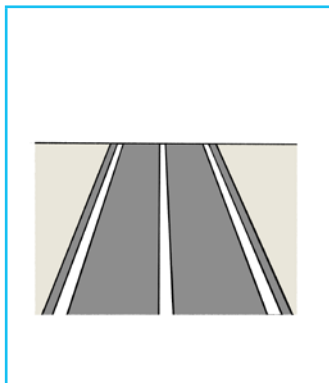

じてんしゃ

バイク

ほどう

どうろ



かきましょう



かけたら、こえにだして よみましょう

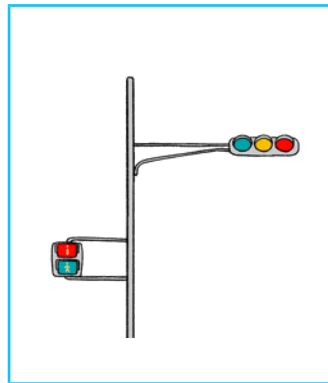
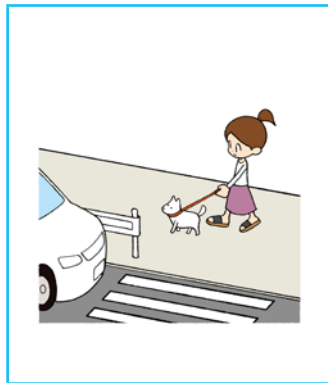
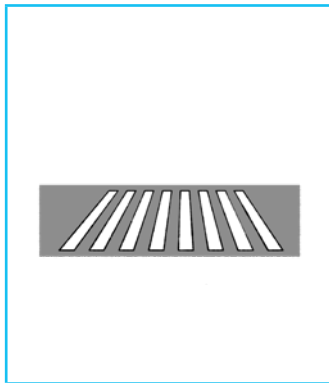
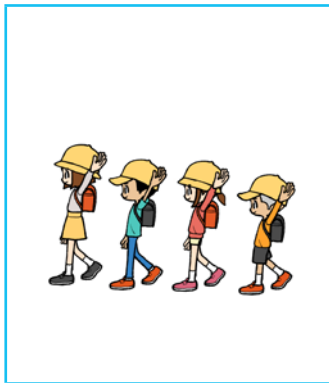

つうがくはん

おうだんほどう

ほどう

しんごう

つうがくはん

おうだんほどう

ほどう

しんごう

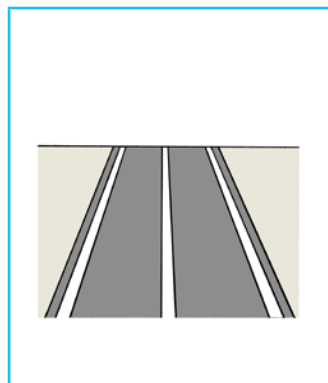
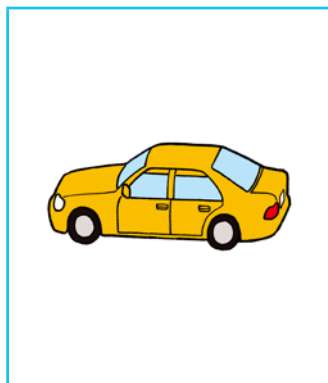
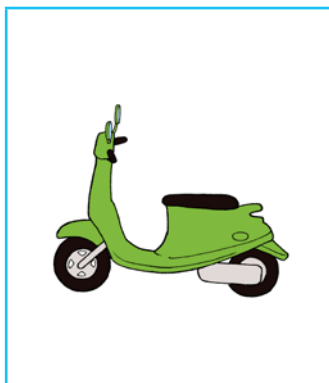
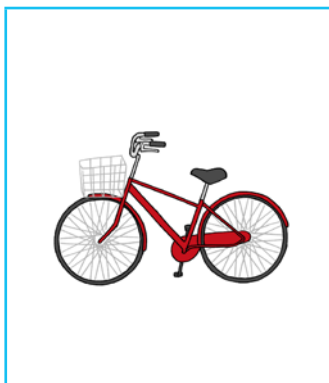
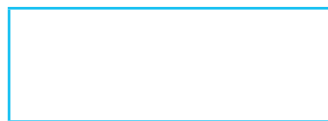
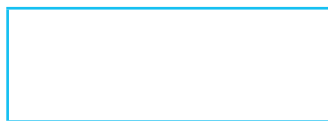
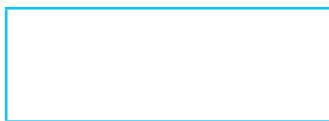
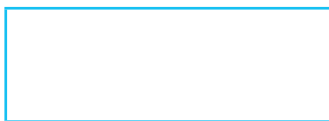

じてんしゃ

バイク

くるま

どうろ

じてんしゃ

バイク

くるま

どうろ

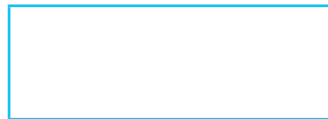
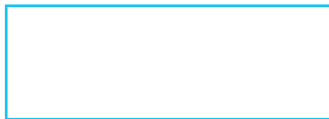
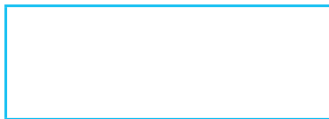



ことばを えらんで かきましょう

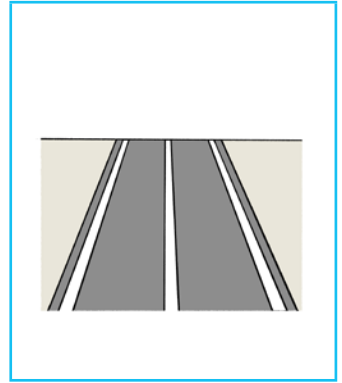
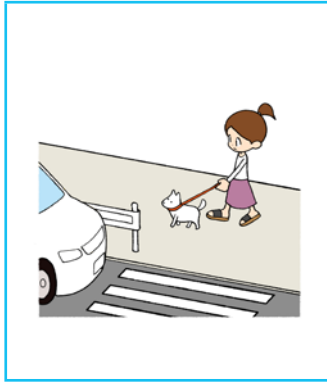

じてんしゃ

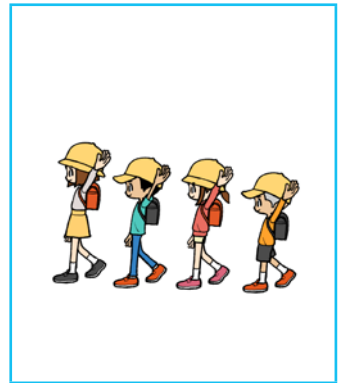
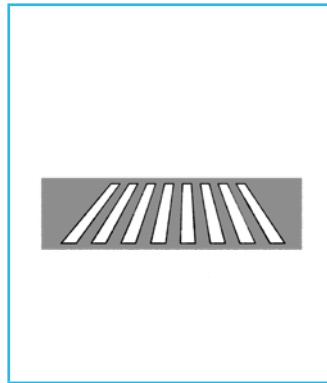
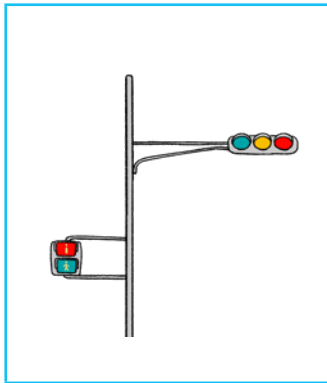
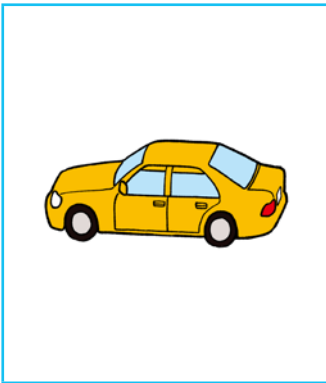

おうだんほどう

じてんしゃ

くるま

どうろ

つうがくはん

ほどう

バイク

しんごう

あぶない！！きをつけよう

あぶない！！

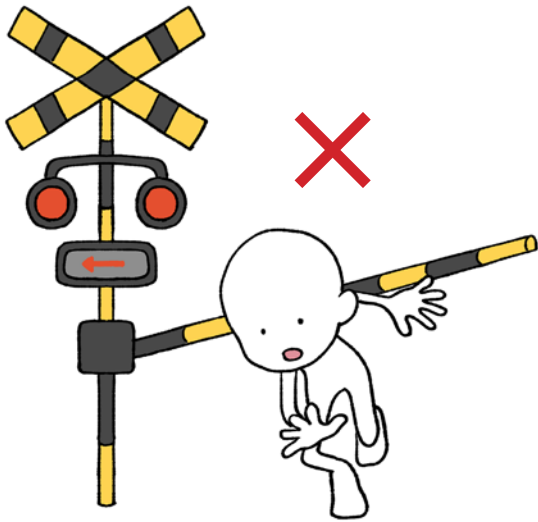

あぶない！！



あぶない！！



あぶない！！



あなたの つうがくろに あるものに ○を つけましょう
○をついたら こえに だして いいましょう

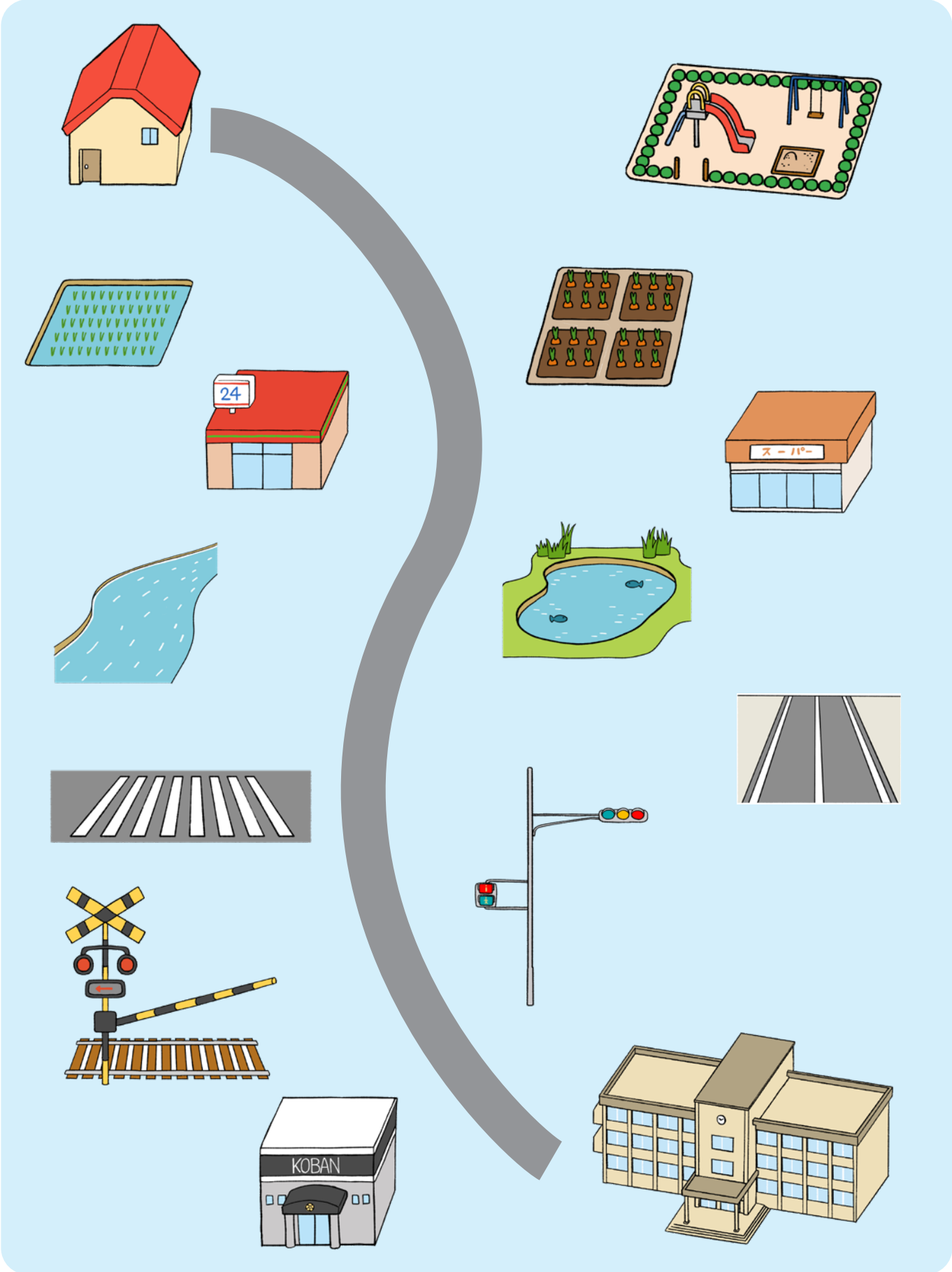

👤 できるようにしたいこと：日付の読みかたや曜日がわかる

11 カレンダー

カレンダーのよみかたをせんせいといっしょにかくにんしましょう

きょうは6がつ17にち(すいようび)です。

6 がつ

げつようび	かようび	すいようび	もくようび	きんようび	どようび	にちようび
1 ついたち	2 ふつか	3 みっか	4 よっか	5 いつか	6 むいか	7 なのか
8 ようか	9 ここのか	10 とおか	11 じゅういちにち	12 じゅうににち	13 じゅうさんにち	14 じゅうよっか
15 じゅうごにち	16 じゅうろくにち きのう	17 じゅうしちにち きょう	18 じゅうはちにち あした	19 じゅうくにち	20 はつか	21 にじゅういちにち
22 にじゅうににち	23 にじゅうさんにち	24 にじゅうよっか	25 にじゅうごにち	26 にじゅうろくにち	27 にじゅうしちにち	28 にじゅうはちにち
29 にじゅうくにち	30 さんじゅうにち					



こんげつの カレンダーを つくりましょう

がつ

ようび ようび ようび ようび ようび ようび ようび



ひにちの よみかたを かきましょう①

6月 1 げつようび	6月 2 かようび	6月 3 すいようび	6月 4 もくようび	6月 5 きんようび
ついたち				

6月 6 どようび	6月 7 にちようび	6月 8 げつようび	6月 9 かようび	6月 10 すいようび

6月 11 もくようび	6月 12 きんようび	6月 13 どようび	6月 14 にちようび	6月 15 げつようび



ひにちの よみかたを かきましょう②

6月 16 かようび	6月 17 すいようび	6月 18 もくようび	6月 19 きんようび	6月 20 どようび
じゅうろくにち				

6月 21 にちようび	6月 22 げつようび	6月 23 かようび	6月 24 すいようび	6月 25 もくようび

6月 26 きんようび	6月 27 どようび	6月 28 にちようび	6月 29 げつようび	6月 30 かようび

日本の季節や季節ごとの行事を確認します。学校や地域ごとの季節の行事があれば、写真や動画などを子どもと一緒に見ながら紹介してください。

にほんの いちねん

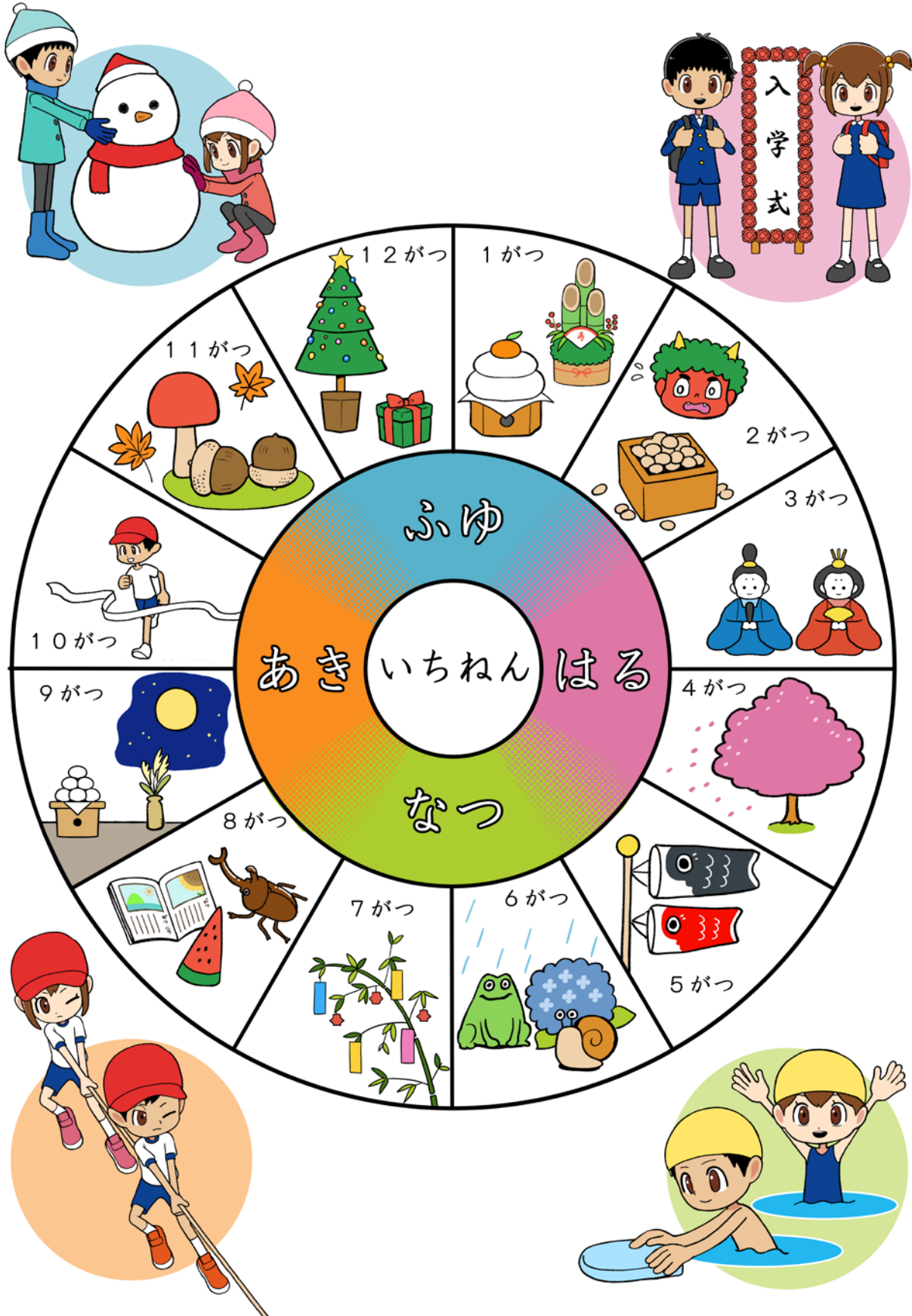

なんの え かな？



おしょうがつに かざる おもちです。
これを 「かがみもち」と いいます。



2がつの 「せつぶん」は 「まめまき」を
します。
「おにはそと ふくはうち」といって まめを
なげます。



3がつの 「ひなまつり」は 「ひなにんぎょう」を
かざります。
おんなのこの おまつりです。

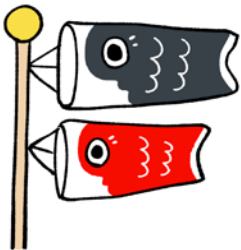

5がつの 「こどものひ」は 「こいのぼり」を
かざります。 こいは さかなの なまえです。

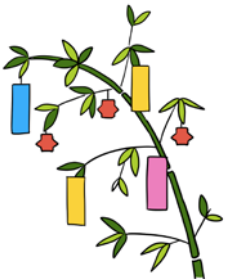

7がつなのはかは 「たなばた」です。 たんざくに
ねがいを かいて ささに かざります。



「じゅうごや」は 「おつきみ」を します。
きれいな つきを みます。

👤 できるようにしたいこと：動作をあらわすことばがわかる 📊

12 どうし

ことばの いみを せんせいと いっしょに かくにん しましょう。

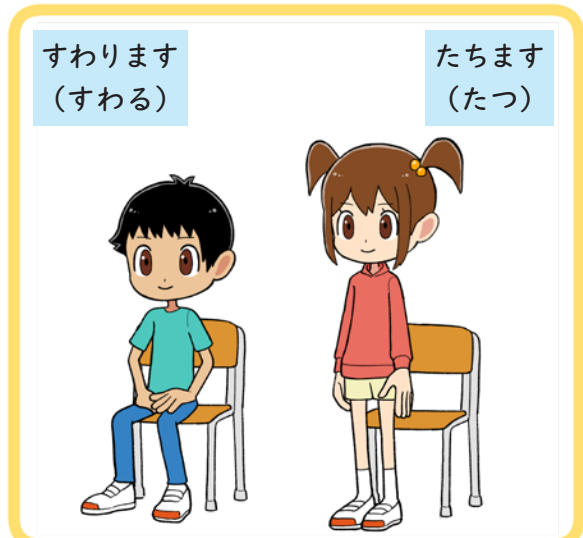
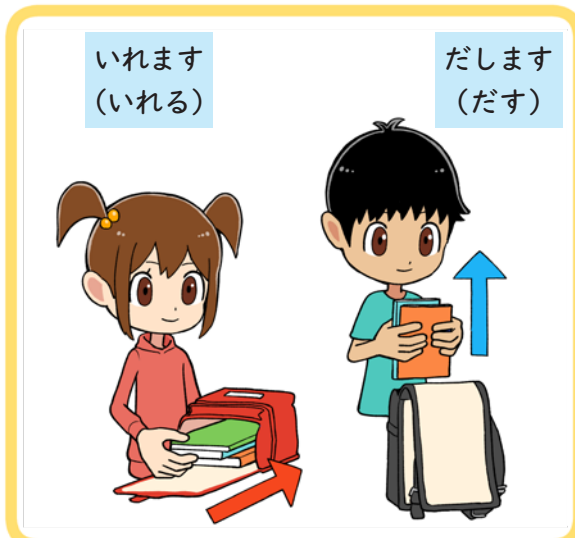
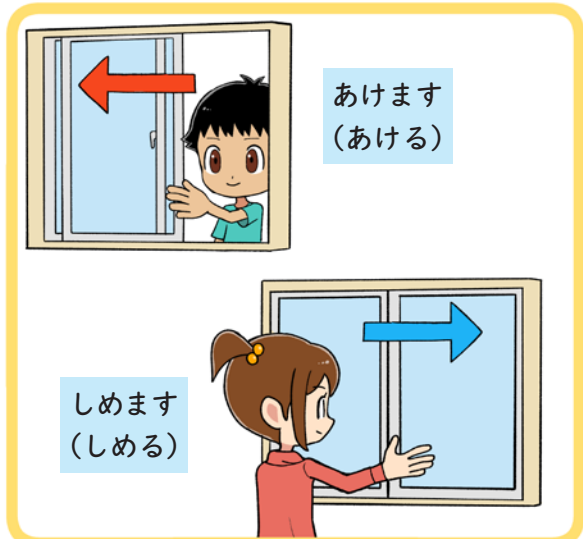
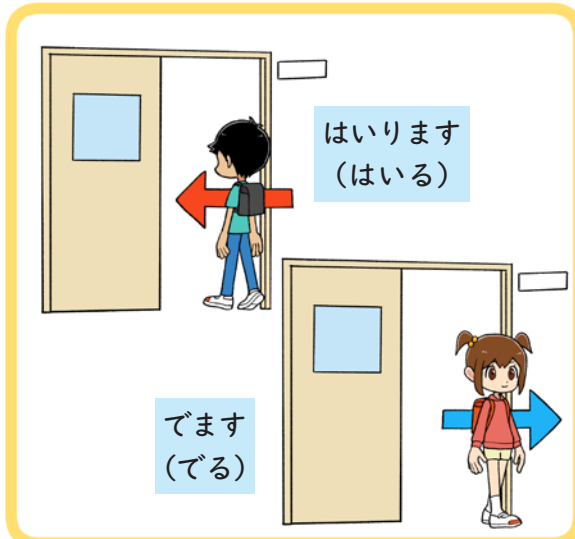
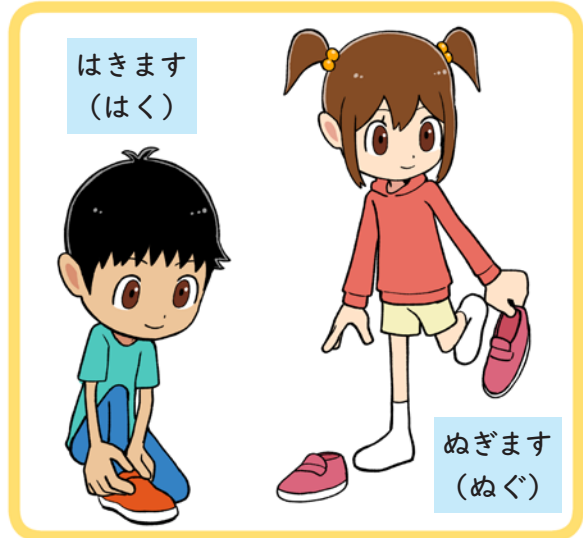
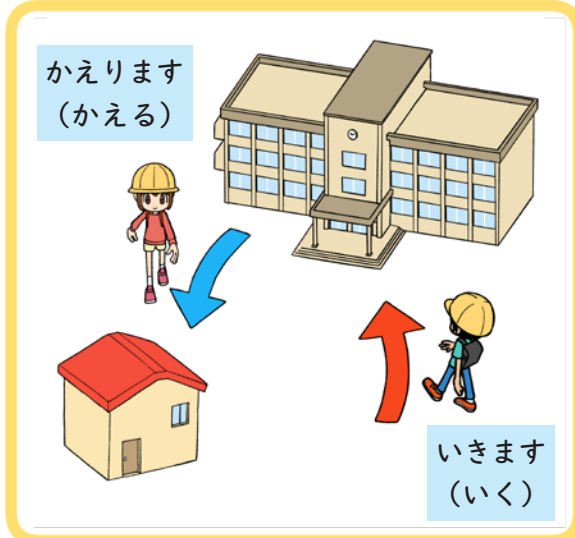

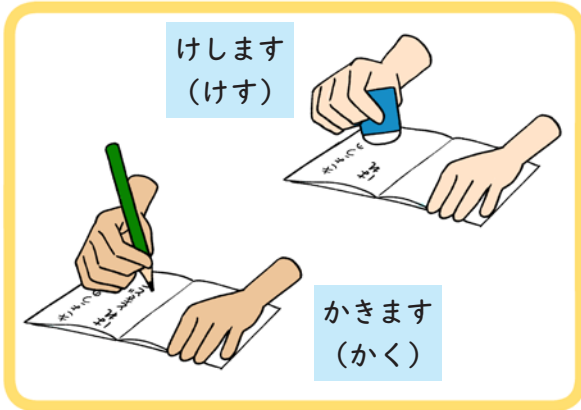
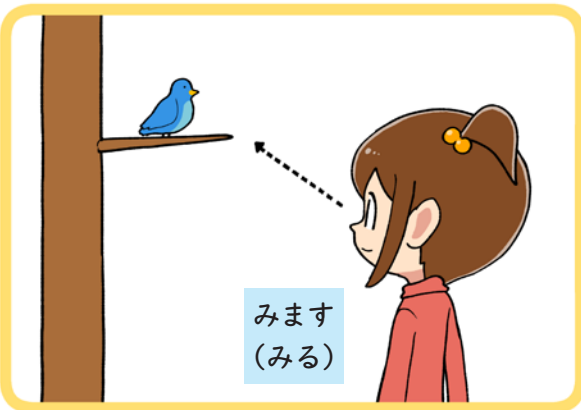
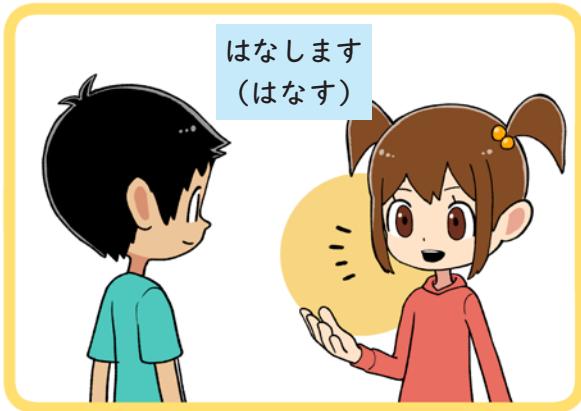

うたいます
(うたう)

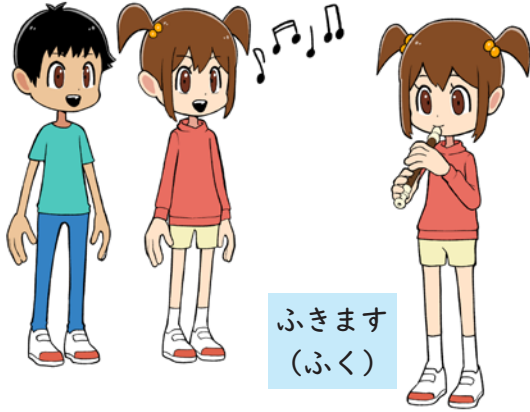

ふきます
(ふく)

きります
(きる)

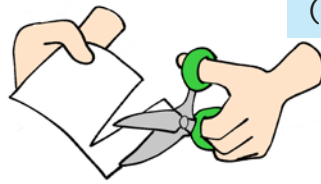

はります
(はる)

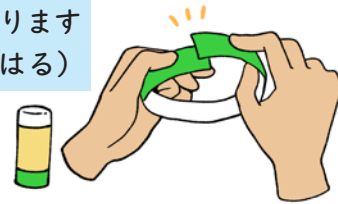

きます
(きる)



ぬぎます
(ぬぐ)



かぶります
(かぶる)



あるきます
(あるく)



はしります
(はしる)



およぎます
(およぐ)



とびます
(とぶ)



せんて むすびましよう

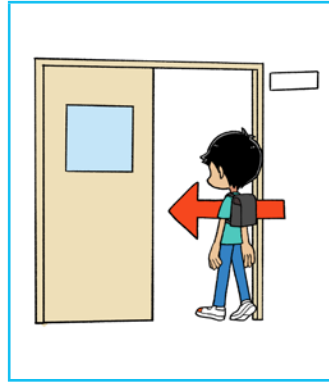
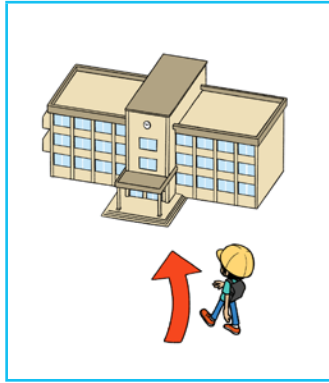
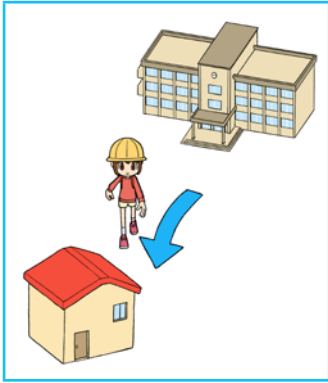

はいります

かえります

でます

いきます

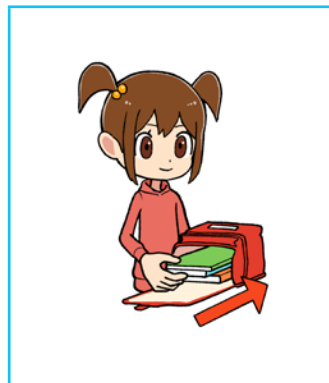
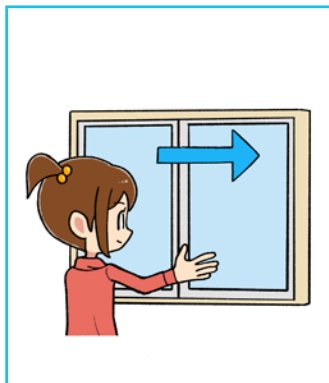
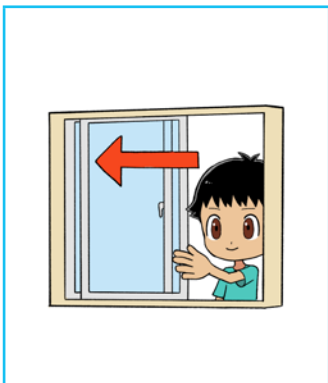

しめます

だします

あけます

いれます

すうじを えらびましょう①

(9)



()



()



()



()



()



()



()

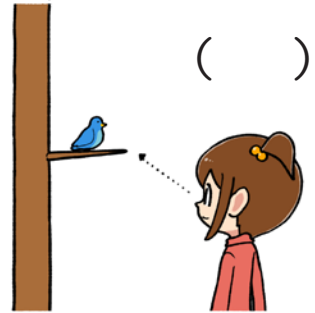

()



()



()



①うたいます

②みます

③たちます

④ふきます

⑤はります

⑥すてます

⑦およぎます

⑧はしります

⑨あらいます

⑩あるきます

⑪きります

すうじを えらびましょう②

(⑤)



()



()



()



()



()



()



()



()



()



① かぶります

② のみます

③ すわります

④ よみます

⑤ かきます

⑥ はなします

⑦ ききます

⑧ とびます

⑨ けします

⑩ たべます



「のみます」ですか？「たべます」ですか？



パン



みそしる



みず



すし



おちゃ



ラーメン



おにぎり



いちご



ぎゅうにゅう



ドーナツ



ジュース

(れい) おにぎり を たべます 。

_____ を _____ 。



「きます」ですか？「はきます」ですか？



くつ



シャツ



パンツ



たいそうふく



ズボン



くつした



うわぎ



したぎ

(れい) シャツ を きます 。

_____ を _____ 。

なにが たべたいですか？



わたしは アイスが たべたいです。

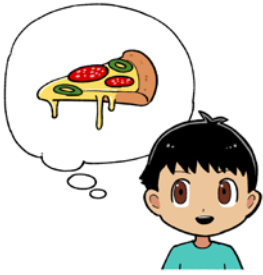

ぼくは ピザが たべたいです。

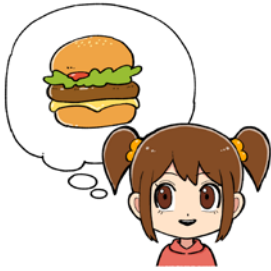

わたしは ハンバーガーが たべたいです。

わたしは／ぼくは

_____ が _____。

「～してください」すごろくの さいころと コマ

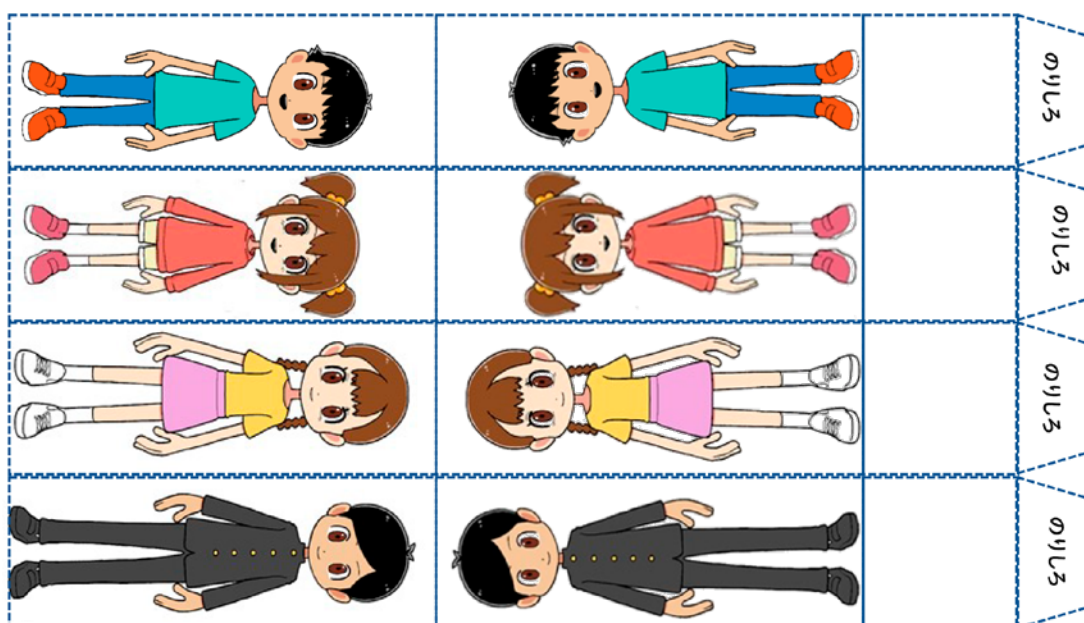
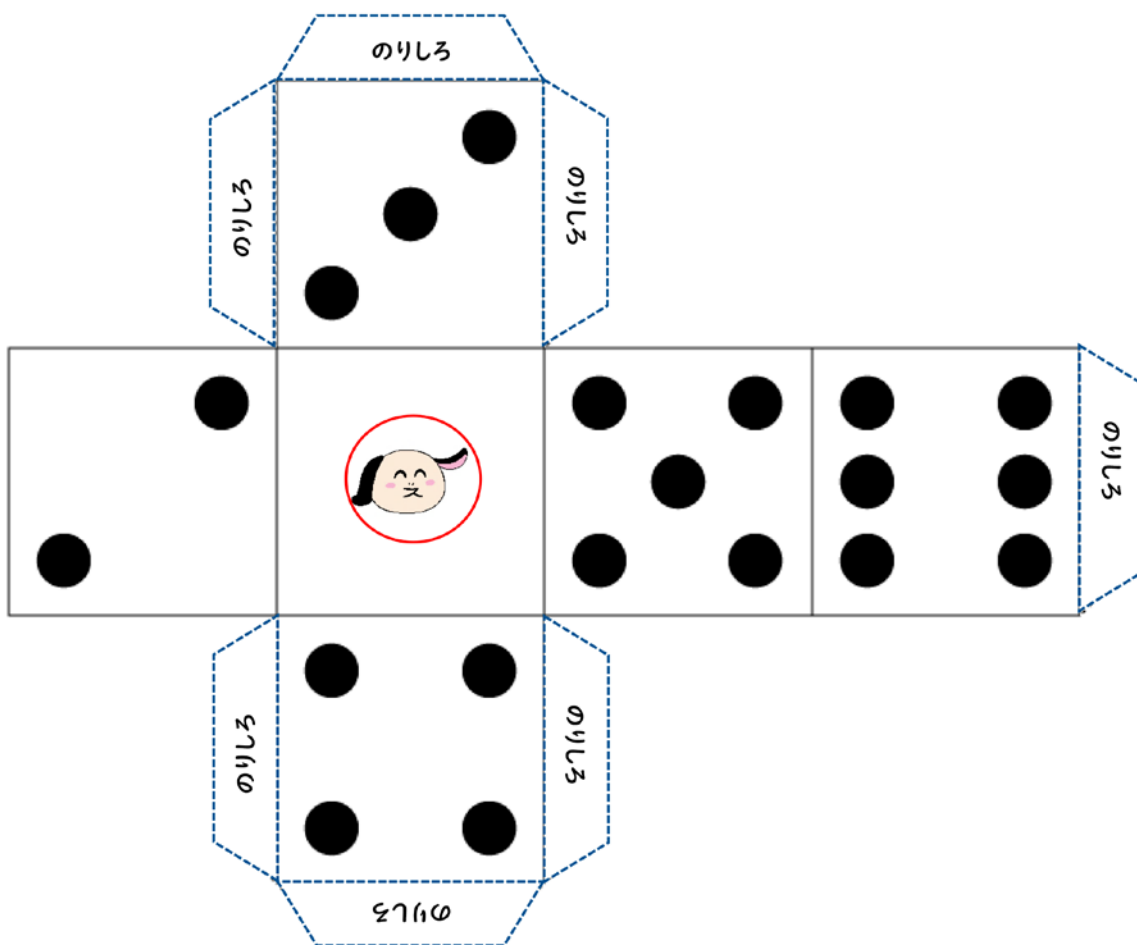

みんなで あそぼう 「～してください」 すごろく

※「とくべつもんだい」は
せんせいと いっしょに
もんだいを かんがえましょう。

あそびかた

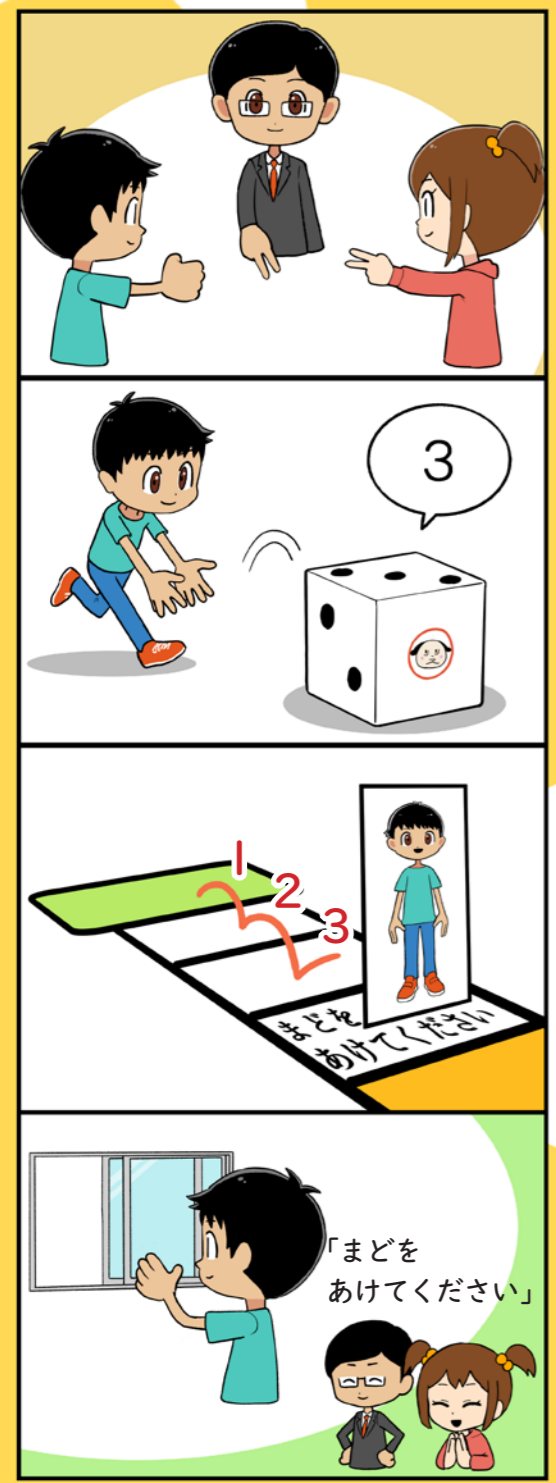

<p>スタート</p>	<p>じぶんの なまえを かいてください</p>	<p>「でます」の はんたいの ことばを いってください</p>	<p>まどを あけてください</p>	<p>2 2コマ すすんでください</p>	<p>とくべつもんだい</p>
<p>うわばきを ぬいでください</p>	<p>あさごはん なにを たべたか おしえてください</p>	<p>1 1かい やすんでください</p>	<p>ことばを つくってください</p> <p>つ う きよ し</p>	<p>(ジェスチャー) なわとびを してください</p>	<p>すきな たべものを いってください</p>
<p>「きます」の はんたいの ことばを いってください</p>	<p>(ジェスチャー) ふえを ふいてください</p>	<p>4 4コマ もどってください</p>	<p>かたあしで 10びょう たってください</p>	<p>すきな きょうかを いってください</p>	<p>とくべつもんだい</p>
<p>ゴール</p>	<p>ふでばこから えんぴつを だしてください</p>	<p>カーテンを しめてください</p>	<p>すきな どうぶつの まねを してください</p>	<p>(ジェスチャー) およいでください</p>	<p>3 3コマ すすんでください</p>

愛知教育大学 外国人児童生徒支援リソースルーム

がっこうせいかつ ことばワーク

2025年3月 初版発行

監 修：川口 直巳 阿部 裕 西山 幸子

執筆／編集：川口 直巳 阿部 裕 西山 幸子 遊佐 美和子

夏目 礼子 五反田 智美 福丸 純子

イラスト：もりけん

発行／問合せ：愛知教育大学 外国人児童生徒支援リソースルーム

〒448-8542 愛知県刈谷市井ヶ谷町広沢1

TEL：0566-26-2219 FAX：0566-26-2566

e-mail：gendaigp@auecc.aichi-edu.ac.jp



本書の全部または一部の営利目的による無断複写・転載を禁じます。

【40ページ】 まちがいさがし①の答え

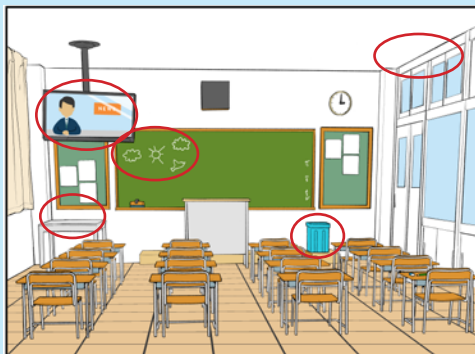

- ・エアコンがありません
- ・テレビがついています
- ・黒板に絵がかいてあります
- ・先生のいすがありません
- ・ごみばこがあります

【41ページ】 まちがいさがし②の答え

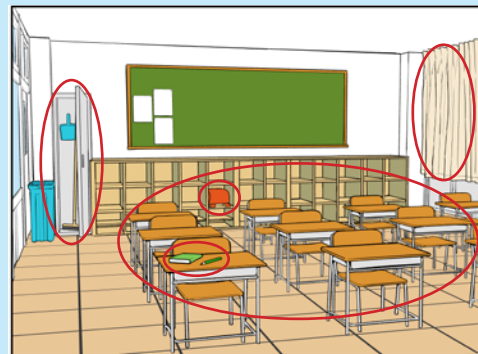

- ・カーテンがしまっています
- ・掃除道具入れがあいています
- ・ロッカーにランドセルがあります
- ・机の上にノートとえんぴつがあります
- ・机といすの数が少ないです

